



MSA NATIONAL STANDING SUPPLEMENTARY REGULATIONS

SA RALLY-RAID CHAMPIONSHIP



REGULATIONS APPLICABLE TO SA RALLY-RAID CHAMPIONSHIP

RACING PART 1: APPLICABLE TO ALL EVENTS

REVIEW AND AMENDMENTS

Amendments and updates to the rules will be recorded in the Amendment Record, detailing the updated version, date of approval of the amendment and a short summary of the amendment.

<i>Modified SSR / ART</i>	<i>Date applicant cable</i>	<i>Date of Publication</i>	<i>Clarifications</i>

SSR 300	ELIGIBILITY OF COMPETITORS	4
SSR 301	ELIGIBILITY OF VEHICLES	7
SSR 302	ROUTE MARKING	10
SSR 303	ROUTE	10
SSR 304	ROAD BOOKS	11
SSR 305	ROUTE DIRECTION AND DEVIATION	14
SSR 306	CONTROLS	14
SSR 307	CLASSIFICATION AND TIME BARS	16
SSR 308	NEUTRAL ZONES ON PUBLIC ROADS	18
SSR 309	ROAD / RAILWAY CROSSINGS	19
SSR 310	PRE- AND POST-RACE PADDOCK AND PARC FERMÉ	19
SSR 311	SERVICE CREW / OUTSIDE ASSISTANCE	20
SSR 312	PRE-RACE PRACTISING AND RACE AERIAL OBSERVATION	21
SSR 313	YELLOW / WHITE LIGHT	21
SSR 314	STARTING ORDER	21
SSR 315	OVERTAKING / BUMPING	22
SSR 316	REFUEL	23
SSR 317	ACCIDENTS / USE OF MEDICAL WARNING BOARDS / INCIDENTS / RETIREMENTS / MISDEMEANOURS	23
SSR 318	PENALTIES	26
SSR 319	TEAM AWARDS	29
SSR 320	CHAMPIONSHIP SCORING	29
PART 2	SA RALLY-RAID CHAMPIONSHIP CAR RACING PART 2 CLASSIFICATION AND VEHICLE SPECIFICATIONS	31

REGULATIONS APPLICABLE TO SA RALLY-RAID CHAMPIONSHIP
PART 1: APPLICABLE TO ALL EVENTS

1.1 General: Wherever reference is made to the President of the *SA Rally-Raid Championship*, it may also include the CEO of the *SA Rally-Raid Championship* and vice versa.

1.2 OFFICIAL NOTICES AND BULLETINS
Refer GCR 17, 67, 70 b) [iii], [v], [vi], [viii], 88, 99 and 100

300. ELIGIBILITY OF COMPETITORS

No competitor shall be permitted to start and compete in an event unless he/she has satisfied the officials concerned that all the following are in order:

- [i] All Entrants, Drivers, second Drivers, Navigators and second Navigators must hold a current MSA Competition licence valid for the event. These licences must be presented at documentation.
- [ii] To obtain a National Competition Licence, competitors will have to have competed in and be classified as a finisher in a minimum of two (2) Regional Cross Country Racing events and have had their licence signed by the Clerk of the Course. A National licence may be issued without the above qualifications if the competitor has competed at National level in other Motorsport disciplines and it has been approved by the CEO of the *SA Rally-Raid Championship*.
- [iii] Where the entrant of a vehicle is not a member of the vehicle's crew, an Entrant's licence must be obtained from MSA, prior to the submission of an entry form. Failing this, the entrant's name will not be published in any documentation for the event.
- [iv] Competitors aged 14 to 16 years may only obtain a competition licence endorsed for Navigational purposes. Competitors aged 17 and older in possession of a learner's or driver's licence may be issued with a competition licence permitting the competitor to drive a vehicle failing which licences must be endorsed for Navigation only. Any competitor in possession of a licence endorsed as a navigator may however drive a vehicle on private property if such conduct is authorized by MSA and/or the relevant Exco CEO.
- [v] **Crew**
 - a) The two persons carried in the vehicle are deemed its crew.
There are three options, namely:-
 - [i] The crew consists of one driver and one navigator for the whole event.
 - [ii] The crew consists of one driver and two navigators.
 - [iii] The crew consist of two drivers and one navigator.All must be clearly indicated on the entry form on entering. In the case of Option [iii], the driver who will be driving the Qualifying race must be clearly indicated on the entry form for seeding purposes and start position.
There may only be a second driver or a second navigator nominated in the crew, but not both.
 - b) The crew of two must be in the vehicle during a competitive section except when rendering assistance in terms of SSR 311. If one of the crew is not in the vehicle whilst racing, the crew will be deemed to have retired. Refer SSR 307 [i] a)
Any competitor who will be in control of a vehicle during an event must be in possession of a valid provincial driver's licence for the type of vehicle entered. Refer GCR 172 [ii].
This applies to ALL events held on or which traverse public roads. Provincial driver's licences must be presented at documentation.
 - c) Should the SR's permit a change of crew/vehicle (Refer GCR 99 [vii]), such change may be permitted prior to the crew having completed documentation.
 - d) Where the crew includes a second driver or second navigator, a crew change may only be made at the designated service point or before the start of the day's racing. The Clerk of the Course must be informed in writing prior to documentation when the change of driver or navigator is to take place. A driver or navigator who completes only the qualifying race will not score any points.
A driver or navigator who completes both loops will score full points in both the class and overall championships.
In [v] a) options [ii] or [iii], the driver or navigator who only completes one loop will score half points in both the class and overall championships.
 - e) A driver or navigator and/or second driver or navigator may only be nominated as the driver and/or second driver or navigator for one vehicle during an event.

- [vi] a) All competitors must have submitted properly completed entry forms.
For National Championship and National Non-Championship Events:
Entries must close not later than ten (10) days prior to the event and late entries must close not later than two (2) days prior to the event. Late entries will only be accepted on payment of twice the set entry fee and a list of late entries must be posted on the official notice board. The restriction of the number of entries must be equal between the categories. An entry will only be accepted when completed in full and proof of payment in full is supplied by the Entrant before the close of entries as per the event's SR's.
- b) All competitors must complete documentation and scrutineering by the closing times as stipulated in the event SR's. Failure to do so may lead to a penalty of sixty (60) minutes. Refer SSR A 318 [vii] d).
- [vii] **NOTE: COMPETITORS ATTENTION IS DRAWN to GCR 239**
- a) All competitors are to wear an approved crash helmet suitable only for motor vehicles/cars on all racing sections.
Motorcycle helmets are not permitted. Only helmets manufactured within five (5) years of the event date will be permitted. Helmets are to be presented at pre and/or post event scrutineering for checking. Crash helmets must be in good condition and not show any sign of damage, cracking and worn webbing etc. Helmets shall comply with GCR 239 Crash Helmets.
Helmets need not be worn on open or de-controlled sections and in the DSP area.
Safety harnesses are to be worn by all competitors, properly fastened, at all times whilst the vehicle is moving. Safety Harnesses shall comply with GCR 239 Safety Harnesses/Belts, and Refer *SA Rally-Raid Championship* Cars Part II 9 Safety Belts. Refer SSR 318 A [viii] d)
- b) During all competitive sections, crew members must wear approved protective clothing from ankles to neck to wrists with a minimum standard of a flame resistant overall. It is strongly recommended that suitable flame resistant underwear is also worn.
- c) It is compulsory for every competitor to wear an approved Frontal Head Restraint (neck brace) on all National races. The approved Frontal Head Restraints include the HANS and Simpson Hybrid – as sanctioned by the FIA Technical List no 29.
All SxS competitors will have to comply with ALL the minimum safety apparel requirements as stated in GCR 239 and SSR 300 [vii]
All regional competitors will have to comply with ALL the minimum safety apparel requirements as stated in GCR 239 and SSR 300 [vii], except the FHR device, which may be replaced by a suitable foam neck brace to the satisfaction of the Chief Medical Officer. Class A regional competitors, however, will be required to wear approved FHR devices. Only in exceptional circumstances where a medical doctor's report is submitted will this be considered for exemption.
- [viii] All vehicles are to carry at least one (1) litre of drinking fluid per crew member at the start of each day's racing.
- [ix] All vehicles are to be equipped with a first aid kit, which shall contain a minimum of the following: -
1 x Space blanket (per crew member)
1 x Triangular bandage
1 x 50mm x 70mm First Aid dressing pad
1 x 50mm x 200mm First Aid dressing pad
1 x 8cm Stretch bandage
4 x Band Aid type strips
4 x Neatseal type plasters (2 x large, 2 x small)
The First Aid kit shall be clean, in good condition and not more than two (2) years old.
- [x] The use of an Exco approved GARMIN GPS device will be compulsory at all events. No competitor may start an event without an approved and operational GARMIN GPS device fitted to the vehicle. Refer SSR 318 A [viii] i)
- a) The Garmin GPS must comply with the following:
1. Must be Garmin technology
2. Must be able to load custom maps onto a SD or Proprietary Garmin Data Card, SD, Micro SD and Garmin Data cards – Must be clearly marked with the competitor number in black ink on white sticker.
3. Must be able to record track logs with a minimum of ten thousand (10 000) points or more.
4. Must be IPX7 rated (can handle wetness but not submersion).
5. Ideally should take an external antenna which should be mounted on the top of the vehicle with the cabling safely routed and protected. Units which do not have an external antenna capability

should be mounted as much into the open as possible in order to obtain the best possible satellite coverage.

6. Power to any unit should be direct via Dual Fuses (positive and negative lines) from the battery.
- b) The Clerk of the Course will be empowered to compare distances and if required will be empowered to download information from a competitor's GARMIN GPS devices. Refer SSR 305 [ii]. Route deviation penalty. Refer SSR 318 A [iii] c) and [v] g).
 - c) The Commission will under separate cover provide guidelines to all competitors to assist in the use of the approved GARMIN GPS device. To request assistance with selection of a GARMIN GPS, please email saccs@saccs.co.za
 - d) A levy of Rand five hundred (R500, 00) will be charged for those competitors requesting their own post-event GARMIN GPS and/or RallySafe downloads. A competitor cannot request GARMIN GPS downloads of another competitor.
 - e) It is the responsibility of the crew to ensure that the GARMIN GPS and RallySafe devices have been activated before taking part in either the qualifying race or the main racing sections. The same applies for the downloading of the GARMIN GPS device after the qualifying race or the main racing sections.
 - f) Reserved
 - g) Vehicles are to be available to Timing and Tracking officials and other start officials a minimum of thirty (30) minutes prior to their designated starting time. Refer SSR 310 [j]. All navigators are to remain with their vehicles, the GARMIN GPS and RallySafe devices must be powered ON and remain so for the duration of the event. Refer SSR 318 A [iii] b)
 - h) RallySafe:
RallySafe is compulsory for all National Competitors.
Failure to have the device mounted in accordance with the instructions and operational will prevent the competitor from starting the event. Refer SSR 318 A [viii] i)
RallySafe Installation Guidelines can be found at <http://rallysafe.com.au/wp-content/uploads/2016/12/Rally-Car-Fitting-Kit.pdf> and must comply with the below:
 - [i] The Antenna Pack is to be installed on the TOP of the vehicle.
 - It must have a clear, unobstructed view of the sky. Failure to do so classifications in poor signal reception and loss of functionality.
 - Any locations other than on TOP of the vehicle are unacceptable.
 - [ii] The three antenna cables must:
 - be routed away from sharp edges
 - not have any bends less than 100mm radius
 - be well protected from damage (add shielding if required)
 - excess cable (if any), must be made into a 200mm diameter loop
 - have sufficient free play at the connections to the RallySafe device
 - [iii] The RallySafe device must be installed in a position and location that it is in clear view and reach of the navigator
 - [iv] Connection of the three (3) antennae cables to the device must be snug to ensure they do not rattle loose during an event.
 - [v] POWER lead – MUST be permanently powered. Fuses/breakers may be installed positive and negative leads, but the device MUST be powered up at all times during an event. The RallySafe unit MUST be powered up no later than thirty (30) minutes before a competitor's start time.
Refer SSR 310 [j] e)

[xi] Competitors Briefing

There will be a competitors briefing before the start of qualifying. The time and place will be stipulated in the SR's of the event or in a Bulletin on the official notice board. Attendance by driver and navigator is compulsory. General information about the event will be discussed. Binding verbal instructions may also be issued by the organisers, and therefore all competitors must sign the attendance register (GCR 88) before commencement of the briefing. When the briefing starts, the attendance registers will be removed. Competitors who have not signed in will incur a five (5) minute penalty each. Refer SSR 318 A [iii] f).

[xii] Monitoring Tools

The Commission reserves the right to install any monitoring tools in a vehicle at its discretion.

301. ELIGIBILITY OF VEHICLES

[i] All vehicles must display advertising decals supplied by the overall championship and the event sponsor. Refer GCR 246 [iii] which makes it a condition of entry to display the sponsor's advertising material. Vehicle and competitors who do not comply with the following provisions (a to l) will not be passed by the Scrutineers. These decals must be displayed as detailed below. Any application for an exemption from this regulation must be made to the Technical Consultant who will make a ruling in consultation with the sponsor's representative and the relevant category's drivers' representative.

a) Number Panel (Large)

The overall championship sponsor's number panel, as supplied, will be prominently displayed on each side of the vehicle and on the roof of the vehicle as per the diagram contained in clause l) of this article.

b) Number Panel (Small)

The overall championship sponsor's number panel, as supplied, to be displayed on the bonnet of the vehicle as per the diagram contained in clause l) of this article.

c) Event Sponsor's Decal

Space must be provided on the side of the vehicle for the Event Sponsor's Decal and must be as prominent as that of the Overall Sponsors.

d) Windscreen/Visor Decal

The overall championship sponsor's windscreen/visor panel, as supplied, to be displayed on the backing decal supplied on the top of the windscreen of all Production Vehicles and on the top of the visor of all Special Vehicles. This decal may be trimmed to fit the profile of the windscreen or visor but must occupy 100% of the area.

e) Racecam Decal/Plate

One (1) Racecam decal or ABS plastic plate, as supplied, to be displayed on the dashboard of all competition vehicles. The position of the decal or plate to be determined by the Racecam technician at the time of the Racecam installation. (Applicable only if provided by the event organisers).

f) Reserved

g) Cloth Badge

One (1) overall sponsor's cloth badge is to be sewn on the left hand side of the chest 10cm below the shoulder of racing suits worn by all competitors.

h) Reserved

i) Reserved

j) Supply of Decals

All overall championship and individual event sponsors' decals will be supplied to competitors free of charge at National Championship events.

k) Competitor's Name

A competitor's name must appear on the front door under the window. Minimum font size four centimetres in height

l) Diagrams:

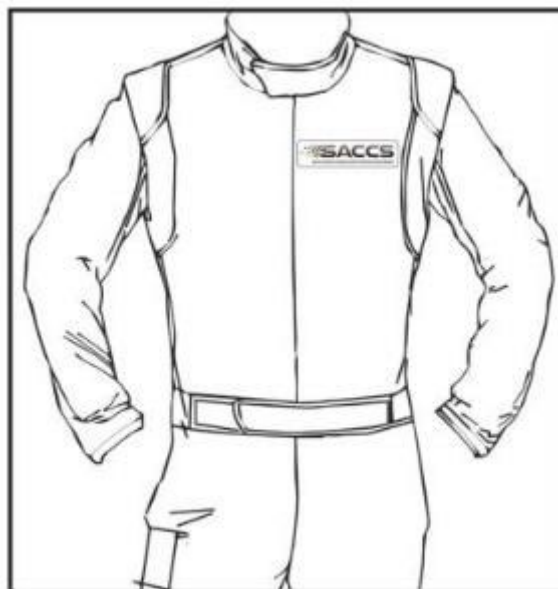

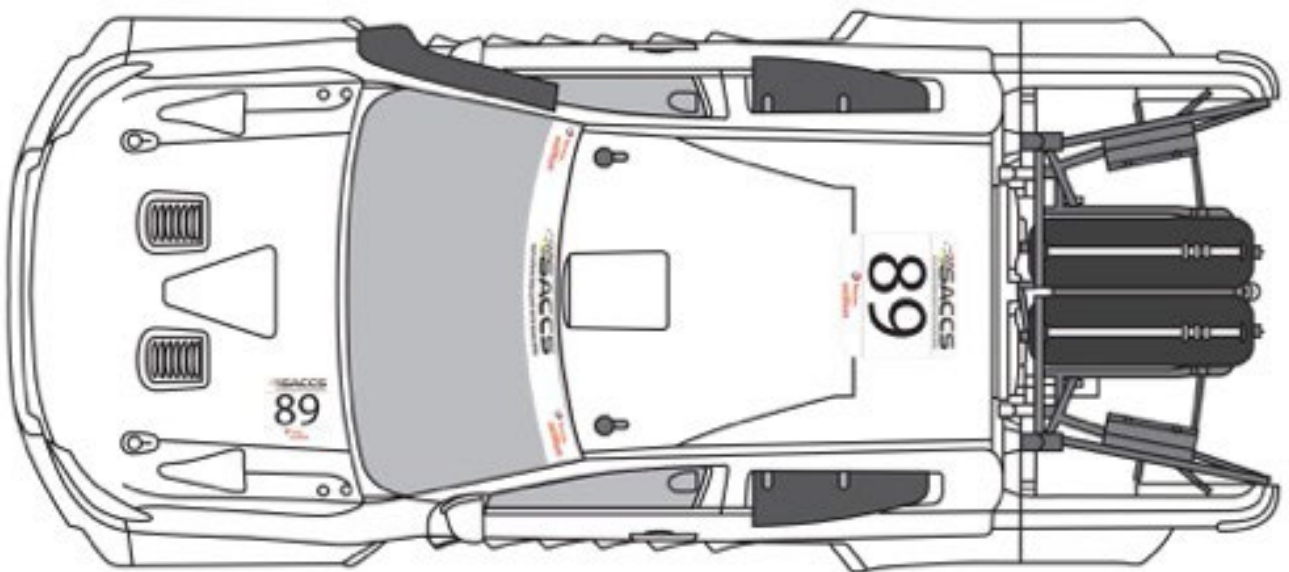
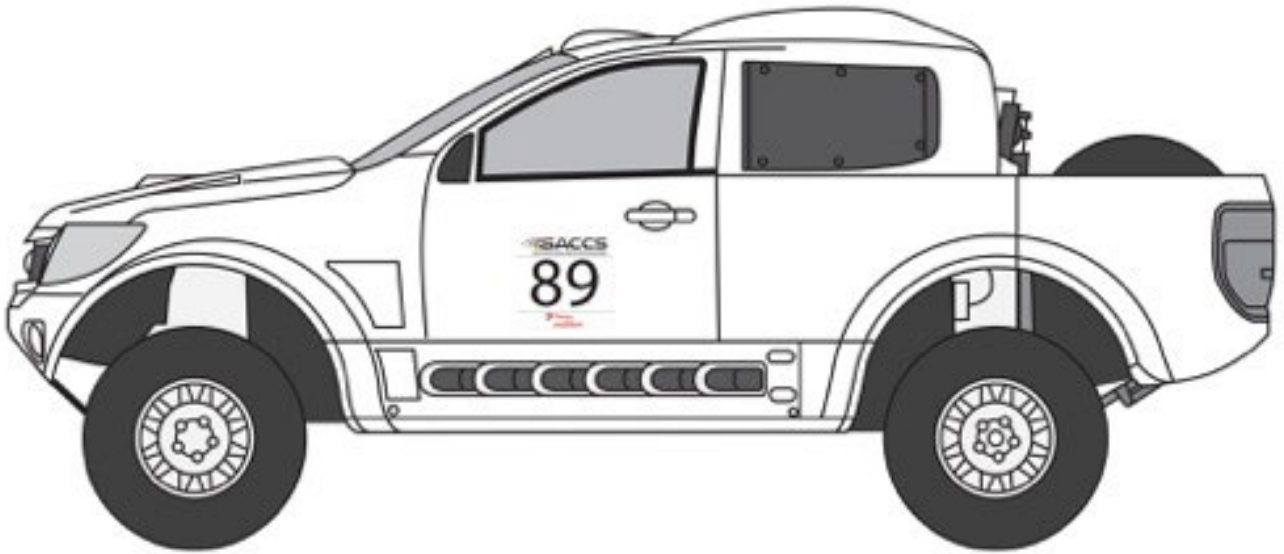

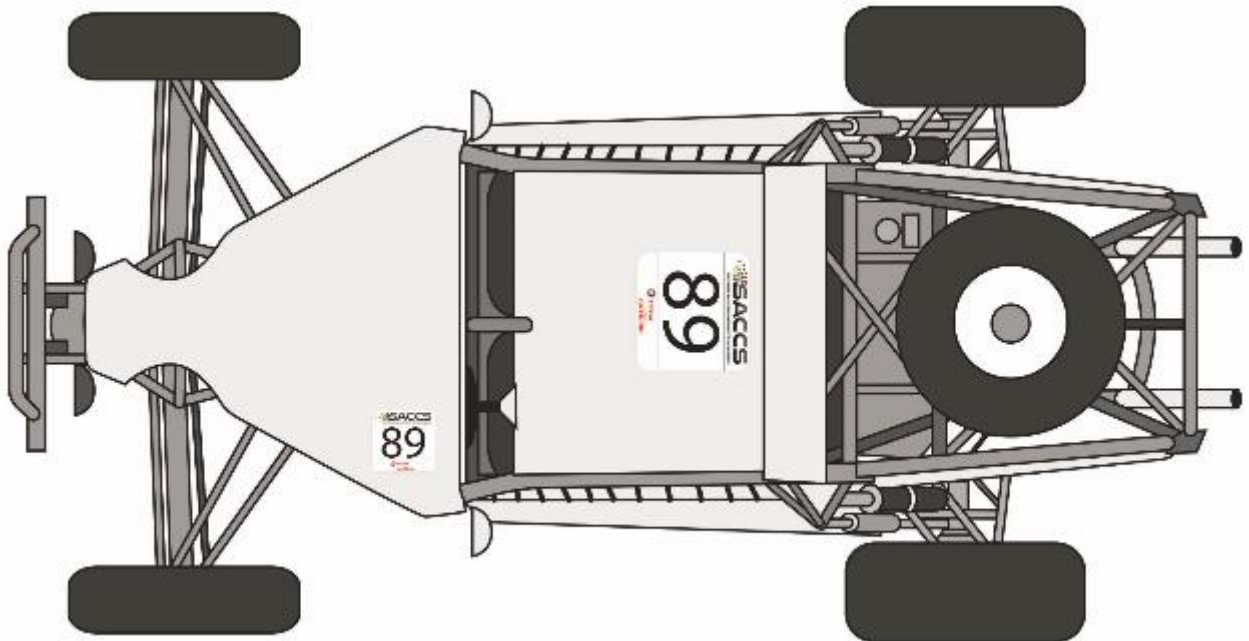
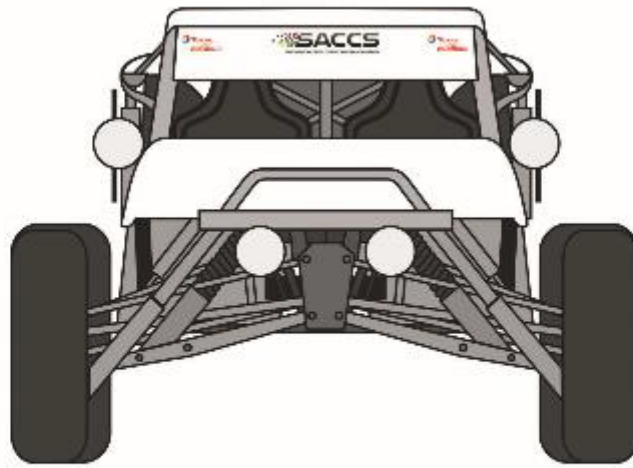
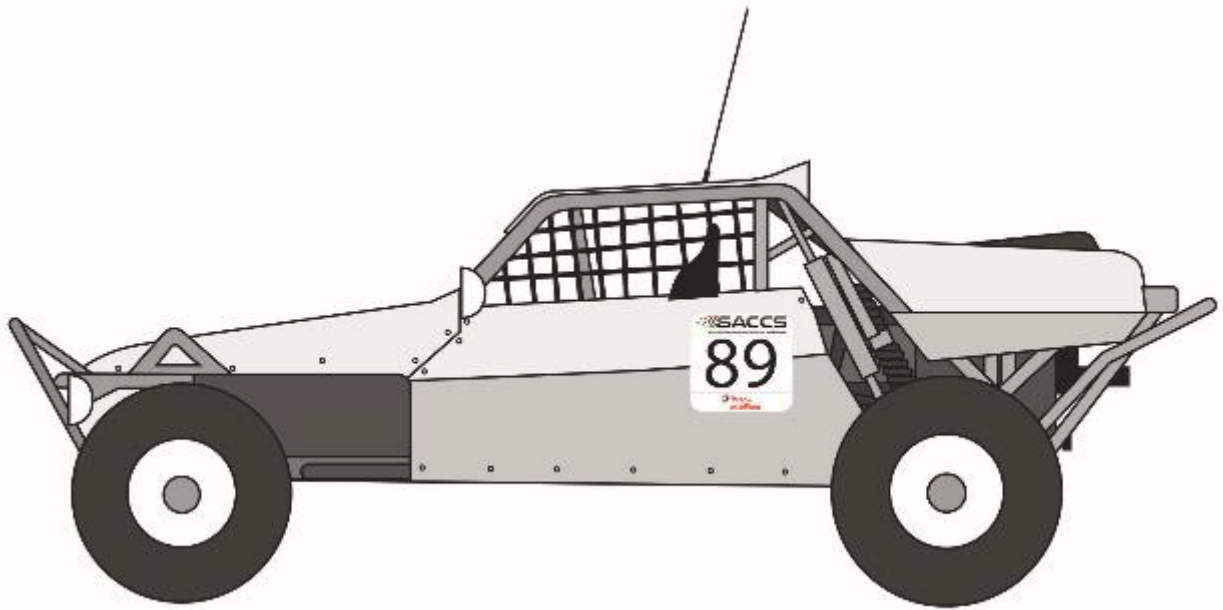

- [ii] All vehicles must display advertising decals supplied by the individual event sponsor/s. Refer GCR 246 [iii] which makes it a condition of entry to display the sponsor's advertising material. These decals must be displayed in a prominent position. The Technical Consultant in consultation with the drivers' representatives will establish all areas on the vehicle where the relevant sponsors' decals will be positioned. Vehicle and competitors who do not comply with the provisions of [i] above will not be passed by the scrutineers. Competitors must ensure that the decals and all advertising material from previous events have been removed.
- [iii] All vehicles must bear MSA allocated competition numbers on the number panels as detailed in clause [i] of this regulation. These numbers must be black on a white background and have a minimum dimension of 200mm x 130mm with a 30mm stroke width per digit. A further competition number with a minimum height of 75mm must be affixed to the number panel on the vehicle's bonnet. Competitors are to obtain their annual competition number from *the SA Rally-Raid* secretariat on 082 991 0011 prior to entering an event. Vehicle which do not comply with these provisions will not be passed by the scrutineers.
- [iv] All vehicles must carry two (2) warning triangles and two (2) medical warning boards, one of which must be cloth, Refer SSR 317 [i], in compliance with MSA's specifications for the duration of the event. Penalty Refer SSR 318 A [v] d).
- [v] All vehicles must conform to the vehicle presented at the initial scrutineering which includes the self Scrutineering documentation. The same chassis and engine block as numbered must be used from passing initial scrutineering until the finish of the event. Refer SSR A 318 [viii] g).

302. ROUTE MARKING

- [i] All route marking must be done with "Day-Glo" markers.
- [ii] Where turns and sensitive areas are indicated, marking may be applied at the discretion of the route director.
- [iii] Danger boards/Xmas trees may be used where a dangerous or extreme change in terrain takes place without warning. Danger boards should have a minimum size of 400mm x 600mm high with an exclamation mark and should be erected approximately 100m before the hazard.
- [iv] "NO GO" areas may be indicated with green "DAY GLO" markers

303. ROUTE

- [i] The route must always be centred around the DSP. The route includes the competitive sections as well as the decontrolled *and liaison* sections.
- [ii] **Distance**
 - a) The distance for a National Championship event is a minimum of three hundred and sixty (360) kilometres including the qualifying race and will be determined by the event format as per the event SR's.
 - b) The qualifying route shall consist of a distance of not less than 5 kilometres for One Day and Super Events and not less than forty (40) kilometres for Standard and Marathon events.
 - c) The following event formats will apply:
 - 1) **Standard Event** with a minimum total combined distance of 360 kilometres which consists of a qualifying race on Friday and racing loops 1 and 2 on Saturday.
 - 2) **Super Event** with a minimum total combined distance of 360 kilometres which consist of Day one and Day two, Day one will comprise a qualifying race and racing loop 1. Day two will comprise racing loops 2 and 3.
 - 3) **One Day Event** with a minimum distance of 360 kilometres. The event will consist of a qualifying race and loops 1 and 2. This format could also be run on two or more consecutive days with each day constituting a new event.
 - 4) **Marathon Events** with a minimum total distance of 900 kilometres including the qualifying race. This event will consist of a Friday qualifying race, followed by loop 1 and 2 on Saturday and loop 3 and 4 on Sunday.
- [iii] Between the race loops, a service allowance of thirty (30) minutes will take place in DSP. The service time will start from the flying finish time as entered on the Time Card. The DSP layout map will indicate the traffic flow direction which must be strictly adhered to. Refer SSR 318 A [iii] d) Contravening traffic flow direction in DSP. Refer SSR 310 [i] f) DSP Stop.
- [iv] In a **Super Event** qualifying and loop 1 forms the Day one section of the event. The cars will go into Parc Fermé after loop 1 for technical checks, and will be released overnight to the crews for Day 2 preparation.
- [v] *The maximum speed limit for all classes at all times is 170km/h, except for class G which is 140km/h. The maximum speed limit may not be exceeded. Refer SSR 308 [iii] and 318 A [ii] a)*

- [vi]** *Road Traffic Regulations on Public Roads*
All National and Local traffic signs will be indicated in the road book and be governed by National and Local Traffic Regulations, rules and signage. Refer GCR 69. The penalty for transgressing any traffic regulation (speed, stopping, overtaking, dangerous driving, etc.) is fifteen (15) minutes per infringement. Refer SSR 318 A [v] k).

304. ROAD BOOKS

- [i]** All competitors will be issued with an electronic Road Book which shall be the definitive document. The Road Book takes precedence over the route marking and any other navigational tools. The road book will create instructions where route changes take place, where there may be doubt in the obvious route, and dangerous places where care should be taken. Where instructions are posted on RallySafe, it will supersede instructions in the Road Book if posted after the start of the race, due to unforeseen circumstances, by the Clerk of the Course. Road Books will be drawn up and prepared for distribution by the *SA Rally-Raid* route director and team. Road book changes may only be done by written instructions signed by the Clerk of the Course.
- [ii]** The route director and team will make every effort possible to ensure the consistency of the Road Book.
- [iii]** All pages of the Road Book will be numbered sequentially.
- [iv]** Every instruction will be numbered sequentially.
- [v]** Emergency numbers will be printed on the bottom of the first page of the Road Book.
- [vi]** The Road Book will be divided into three columns:
 a) Column One (1) will be used to display distance
 i) At the top of each row in column one the Total Distance will be indicated.
 ii) At the bottom right of each row in column one the Intermediate Distance will be indicated.
 b) Column Two will have a hand drawn picture of the instruction.
 c) Column Three will contain any additional notes that the race organisers wish to bring to the competitors attention.
- [vii]** Each page of the Road Book will have five (5) instructions per page.
- [viii]** The margins of the Road Book will be set.
- [xi]** The legend and text will be clearly legible and will be at least 5mm in height.
- [x]** The Total Distance will be indicated in Arial Bold at a size of 65 at the left top corner of the instruction.
 Example:

0.00

- [xi]** The odometer Intermediate Distance will be indicated in Arial Bold at a size of 45 at the left bottom corner of the instruction. Example:

0.35

- [xii]** The line indicating the required direction will be a weighted 6pt solid line for example.



- [xiii]** Any other tracks that need to be indicated will be in a thinner line weight for example:



- [xiv]** All diagrams will contain a short line with a dot at the end (distance indicator pin) to indicate the point on diagram to which the distance applies.
- [xv]** The distance indicator pin will be placed at the most dominant characteristic of the instruction. (Where possible an identifiable landmark) and the distance between instructions is measured to this landmark. For example, if there is a right turn, it will be in the corner of the turn.

- [xvii] Should there be a second aspect to one instruction the distance is from the distance indicator pin to that of the second aspect. For example, if there is a 90° right turn and 120m further there is a split left, the 120m will be indicated in the picture column.
- [xviii] When there are two or more dips or humps in one picture the distances between them must be indicated.
- [xix] The Total Distance indicator will be measured from Start to Finish.
- [xx] Intermediate Distances will be measured from instruction to instruction. Please note it is possible that distances do not add up to the total by 10 metres due to rounding off.
- [xxi] Stay on the main track unless otherwise indicated in the Road Book.
- [xxii] All "STOPS" at road/railway crossings and district roads (public roads) as well as EXTREME changes to terrain (Danger marking) will be indicated in the Road Book. It will be endeavoured to make all road crossings as close to perpendicular with the road to be crossed as possible. The driver should also try to stop as perpendicular as possible to have the best view of approaching traffic.
- [xxiii] Danger will be indicated with different levels of caution **(!, !!, !!!, !!!!)**.
- [xxiv] Instructions will not be duplicated in the comments column, this column is purely for extra information.
- [xxv] "No Trail" sections where markers must be followed, will be indicated by a dotted line and single caution.
- [xxvi] All villages, kraals, farmhouses or homesteads, where you might encounter people or spectators will be indicated with a single caution.
- [xxvii] The angle in relation to a gate or an opening in a fence will be indicated for example:

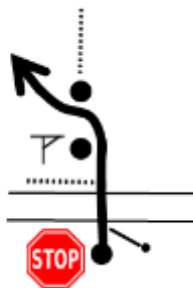

- [xxviii] *A bearing could be included in any road book instruction.*

TRACKS		ZONES		SYMBOLS		SYMBOLS		ABBREVIATIONS	
	TARMAC ROAD		START		FENCE		PETROL STATION		LEFT AND RIGHT
	TRACK		DEPARTURE SELECTIVE SECTION		BARBED WIRE FENCE		MONUMENT		LEFT AND RIGHT
	OFF PISTE OFF TRACK		FINISH		RAILROAD		ANIMALS INDIVIDUAL		RIGHT AND LEFT
	LESS VISIBLE OLD TRACK		ARRIVAL SELECTIVE SECTION		HOLE		ANIMALS		ON THE LEFT ON THE RIGHT
	PISTE TRACK		TIME CONTROL		HOLE COLLAPS		CAIRN		KEEP TO THE LEFT
	MAIN PISTE MAIN TRACK		CONTROL ZONE END		BUMPY		ROCKS INDIVIDUAL		KEEP TO THE RIGHT
	ROAD		START OF SERVICE AREA		TWISTY		MOUNTAIN INDIVIDUAL		KEEP STRAIGHT
	PARALLEL TRACKS		FINISH OF SERVICE AREA		SUMMIT		TREE INDIVIDUAL		MORE / LESS VISIBLE
	OFF PISTE		PASSAGE CONTROL		RUTS		PALM TREE		MORE VISIBLE
	OFF PISTE FORBIDDEN		START OF NEUTRALISATION		LATERAL INCLINATION		CAMEL GRASS		LESS VISIBLE
	FOLLOW MAIN PISTE		FINISH OF NEUTRALISATION		POST		VEGETATION		NEXT
	FOLLOW ROAD		REFUELING POINT		ELECTRIC POLE		VEGETATION		AT
SAFETY		ON TRACK			ELECTRIC LINE		TALL GRASS		INTO
	DANGER 1		NARROW		HIGH VOLTAGE TOWER		SMALL WADI		BIG
	DANGER 2		BUMP		ANTENNA MAST		LARGE WADI		SMALL
	DANGER 3		DIP HOLE		WELL		SANDY WADI		ALWAYS
	DANGER FOR ALL SYMBOLS		COMPRESSION		WATER TANK		RIVER		STONY/ROCKY TRACK
	START ZONE SPEED LIMIT		DITCH		BARREL		WATER AREA SEA, LAKE		STONE/ROCK ON TRACK
	FINISH ZONE SPEED LIMIT		ABOVE BRIDGE		KILOMETER MARKER		PLAIN		QUIT LEAVE
	SPEED LIMIT		UNDER BRIDGE		TYRE		RESTRICTED AREA		QUIT / LEAVE MAIN TRACK
	FINISH OF SPEED LIMIT		DOWN HILL		SIGN POST INDIVIDUAL		DISTANCE IN METER		MANY
	STOP		TOWARDS		HOUSE		DISTANCE FROM TRACK		IMPERATIVE
	SLOW DOWN		UP HILL		BUILDINGS INDIVIDUAL	DUNES / SAND			COLLAPSED
WAYPOINTS			STEP DOWN		CHURCH MOSQUE		SMALL DUNE		BAD
	WAYPOINT MASKED		STEP UP		RUINS INDIVIDUAL		SMALL DUNES		ROUGH
	WAYPOINT ECLIPSE		LEFT OVER CREST		FORT		BROKEN DUNE		GET AROUND
	WAYPOINT VISIBLE		RIGHT OVER CREST		CEMETERY		SAND SPIT		NARROW
	WAYPOINT NAVIGATION		GATE BARRIER		VILLAGE		BIG BOWL IN DUNES		GRAVEL
	WAYPOINT SAFETY		GATE BARRIER		BIVOUAC		SAND PLAIN		AND
DIRECTION			CATTLE GATE BARRIER		TUNNEL		DUNES		BETWEEN
	BEARING (CAP)		WATER CROSSING		PIPELINE		DUNE		REJOIN
	BEARING AVERAGE		CONCRETE		WALL		DUNES		FOLLOW ALONG
	BEARING CALCULATED		CONCRETE IN WATER		STONE WALL		SAND		VALLEY

305. ROUTE DIRECTION AND DEVIATION

- [i] No competitor may drive on the route in a direction which opposes the flow of competitors driving in the direction stipulated in the Road Book. Refer SSR 318 A [viii] e).
A competitor may only leave the designated route when circumnavigating an obstruction or when overtaking, this must be done by staying close to the route as indicated in the Road Book.
- [ii] Deviation shall be deemed as having taken place from where you left the route to where you first re-join or cross the route when either an advantage in distance or time has been gained by such deviation. Refer SSR 300 [x] b).
- a) For minor deviation from the route or not following a road book instruction correctly: If and where a time advantage of less than sixty (60) seconds has been gained as recorded by the logged data, or a distance gain of sixty (60) metres or more, a two (2) minute penalty plus time advantage gained will be applied on recommendation of a jury comprising the Clerk of the Course, Timing and Tracking Manager and the Route Director. The time advantage gained will be calculated using a competitor in the same class closely matched in speed through the correct route as a reference time. Refer SSR 318 A [iii] c).
- b) For major deviation from the route: If and where a time advantage of sixty (60) seconds or more has been gained as recorded by the logged data, or a distance gain of greater than one (1) kilometre, a fifteen (15) minute penalty plus, time advantage gained will be applied on recommendation of a jury comprising the Clerk of the Course, Timing and Tracking Manager and the Route director.
The time advantage gained will be calculated using a competitor in the same class closely matched in speed through the correct route as a reference time. Refer SSR 318 A [v] g).
- [iii] In the case where a competitor gets lost on the route, the deviation shall be corrected by re-joining the route as close as safely possible to the original point of deviation, so as not to be penalised as per SSR's above. When backtracking to find the correct route, competitors shall drive slowly next to the road where possible, and exercise extreme care so as not to meet competitors from the front who may follow the same incorrect track created by the first offender or meet competitors head-on on the correct route and direction. Ensure that the correct direction of flow is followed when re-joining the correct route safely.
Refer: GCR 172, GCR 173, SSR 318 [viii] e) and SSR 318 B (i) c)
- [iv] Corner cutting by shortening the corner to the inside *or extending to the outside* will not be allowed. Corner cutting usually takes place in ploughed farmlands, and upsets the landowners. A marker may be placed *inside the corner* in the vicinity of the corner apex *or outside the corner at the corner entrance and/or exit*. The competitor has to drive around the outside of the *apex* corner marker *or inside the entry and exit markers*. Should the competitor drive *on the wrong side of* the marker, or flatten or take the marker out, the penalty will be two (2) minutes per offence. More than three corner cut transgressions per event may lead to the Clerk of the Course increasing the penalty. RallySafe and cameras may be used as evidence. Penalties may be applied during or after the event. The onus will be on the competitor to prove innocence.
Refer SSR 317 [v] and SSR 318 [ii] b)

306. CONTROLS

[i] Timing Controls

Controls will be identified by control boards and operated by appointed event officials.

There are two types of control - a flying finish control and a time control:

- The flying finish control is where the competitor's time is recorded on the official event clocks. The flying finish will be identified by a set of flying finish control boards. The competitors are not required to stop at this point, but must stop at the time control. A flying finish control will operate at the end of each controlled racing section.
- The time control will operate at the start and end of every controlled section, e.g. the start and end of racing section (with flying finish), start and end of a *neutralised zone*, the entrance and exit of DSP and wherever required by the Clerk of the Course. At the time control (combined with the flying finish at the end of a racing section), the competitor's arrival time will be recorded on the official clock in hours, minutes and seconds GPS time. This time will be entered onto a timecard where indicated, as well as on a sequence sheet. The times recorded on the official clocks, timecards and sequence sheets will be used as a back-up in the case of timing failures. The Clerk of the Course may use his discretion to employ alternative methods such as the official clocks, timecards, sequence sheets or manual timing. Early departure from start controls (jump starts) will carry a ten (10) minute penalty. The time difference between the allocated time and the actual time taken (the time by which early departure took place) will be added to the ten (10) minute penalty. Refer SSR 318 A [iv] a).

Missing a control or failing to stop at the control or ignoring a control official's instruction carries a

sixty (60) minute penalty. Refer SSR 318 A [vii] b.

[ii] Control Area

The area between the first set of control boards as recognisable by the letter M and thereafter by the Stop sign(s) signifies the Control Area which is deemed to be a Parc Fermé. In this control area, the following is not allowed:

- No servicing or working on a vehicle. If a vehicle breaks down in the control area, it may only be pushed out far enough to clear the control area and to allow passage for other competitors. Thereafter SSR 311 applies.
- No overtaking. When a competitor has stopped at a control official and another competitor approaches, the second competitor may not pull up alongside the stationary competitor. The competitor must wait for the control official to complete all formalities with the first competitor and be called in by the control official. No waiting time will be allowed. For non-compliance to the conditions, Refer SSR 318 A [v] e).
- A competitor may not enter a control from the opposite direction to the traffic flow. This includes reversing. Refer SSR 305 [i] and SSR 318 A [viii] e).

[iii] Neutral Zone and procedure

Neutralisation of any racing section will start with the receipt of the timed decontrol slip at the start of the *neutral zone*. The onus is on the crew to ensure all times recorded on any timecard by an official is correct. The onus is also on the crew to calculate their given times on the Timecard to ensure they arrive timeously at various controls which may include DSP controls indicated on this Time Card. The crew must report to all time controls for the time controller to record the time on their sequence sheet so that the time controller can prepare the start of the crew on the correct time for the next section. *Neutral zones may also be operated by RallySafe*. Refer *SSR 308*, 318 A [iii] e), [iv] a), and [vii] b).

[iv] Standard Signs to be used on National Championship Events:

- a) **Light Check Control:** Round signs on white ABS plastic 300mm in diameter. "Light Check" in red lettering with "OK" in green lettering printed on the reverse side in such a way that, when the board is turned over, the letters must be the right way up. This board will be mounted on a pole of not less than 1m in length so that the marshal can hold it out in front of a competitor. If light checks are situated at road crossings, it should be situated ~~400~~ 50 meters after the crossing to avoid interference with the crossing.

Light check controls will be demarcated by a danger sign followed by a Marshall sign (M) at ~~400~~ 50 meters and then ~~400~~ 50 meters to Stop *at* the marshal with the Light Check and OK sign. Competitor to stop at the marshal, and only leave when the OK sign is shown. It is not compulsory to include the stop in the Road Book or on RallySafe.

Failing to stop at the control or ignoring a control official's instruction carries a ten (10) minute penalty. Refer SSR 318 A [iv] c and SSR 313.

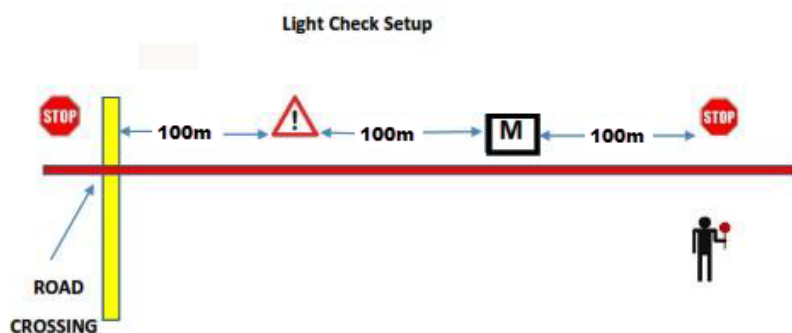

- b) **Crossing** Black cross on a white background. This sign should be placed on a board with a minimum dimension of 600mm wide x 600mm high (suggested material "Corraplas"). This should be placed 100m before the road/rail crossing.



- c) **Marshal** Black on a white background. This sign should be placed on a board with a minimum dimension of 600mm wide x 600mm high (suggested material: “Corraplas”). This board should be placed **50m** before a marshal point.

M

- d) **Danger** Black on a white background. This may be placed on a board with a minimum dimension of 600mm wide x 600mm high (suggested material “Corraplas”). This board should be displayed **200m** before a road crossing, marshal point, refuel or service area and extreme change of terrain. Alternatively, a caution could be identified by numerous “Day-Glo” stickers to indicate danger.



- e) **Extreme Change of Terrain** Red on white chevron pointing downwards may be placed with a minimum dimension of 300m wide x 500mm high. Alternatively, a change of terrain could be identified by numerous “Day-Glo” stickers to indicate the change in terrain.



- f) **Stop Sign** White on red background. Hexagonal shaped with a minimum dimension of 300mm wide x 300mm high. This sign should be placed on a board with a minimum dimension of 600mm wide and 600mm high. This board must be placed at road crossings and at marshal points. *The stop board must be placed at the exact location of the RallySafe GPS pin.*



- g) *Reserved. Refer SSR 308.*
h) *Reserved, Refer to SSR 309*

307. CLASSIFICATION AND TIME BARS

[i] Finisher:

In order to be classified as a finisher of an event the crew of two must start and complete the full distance of the event, as specified in the SR's/Final Instructions or any other official notice published by the organisers, within the time provided and under its own power. However, in the case of a DNF in Qualifying and/or the Main race, a restart will be allowed with the applicable penalty added. Refer SSR's 300 [v] b), 311 [v].

[ii] Qualifying Race Classification:

The qualifying race start time for each competitor will be as published in the start order document by the organisers. Race end time will be the final control flying finish time of each competitor. Elapsed time will be calculated as final control time minus the qualifying race start time of each competitor. The elapsed times including penalties will be classified from shortest to longest.

Competitors who finished the qualifying race within one and a half times of the fastest qualifying time in their class will have their qualifying race time including time penalties added to their overall race time. All competitors who finished, including time penalties, outside one and a half times of the fastest qualifying time in their class, will be deemed non-finishers and will get one and a half times the fastest qualifying time in class added to their **overall** race time. Competitors who entered but did not start the qualifying race will get two times the fastest qualifying time in their class added to their overall race time. Protests received disputing the classifications of the qualifying race will be heard by the Stewards of the meeting, and their final decision will determine the starting order for the Main race.

[iii] Main race Classification:

a) Standard and One Day Events:

The main race start time for all competitors will be the start time as published in the start list based on qualifying times, or any other official notice published by the organisers. Race end time will be the final control flying finish time of each competitor. Elapsed time will be calculated as final control time minus the competitor's main race start time. The Main race elapsed times including time penalties will be classified from shortest to longest. Refer SSR 306 [i].

The category and class winners will be declared on the shortest main race time plus qualifying race time in the respective category and class.

b) Super Events:

The Super Events will be run as one event over two days, consisting of a qualifying race and main race loop 1 on Day one, and loops 2 and 3 on Day two. The main race loop 1 start time for all competitors will be the start time as published in the start list based on qualifying classification, or any other official notice published by the organisers. Loop 1 end time will be the final control flying finish time of each competitor. Elapsed time will be calculated as final control time minus the competitor's main race loop 1 start time. The loop 1 elapsed times including time penalties plus qualifying race time including time penalties, will be classified from shortest to longest. Refer SSR 306 [i]. This will be the competitor's classification for Day one as published in the Partial Provisional and Partial Final classification which will determine the starting order for Day two.

Protests received disputing the classification of Day one will be heard by the Stewards of the meeting, and their final decision will determine the starting order for Day two. **DNF** in Day one loop 1 will be allocated a start position for Day two loop 2 as per SSR 311 [iv], including time penalties. Day two race end time will be the final control flying finish time of each competitor. Elapsed time will be calculated as final control time minus the competitor's Day two race start time. The Day two race elapsed times including time penalties will be classified from shortest to longest. The sum of the elapsed times for Day one and Day two will be classified from shortest to longest. This will be the competitor's classification for the event.

The category and class winners will be declared on the shortest main race time including time penalties plus qualifying race time including time penalties in the respective category and class.

c) Marathon Race:

The Marathon Race will be run as one event, consisting of Qualifying, Day one and Day two. Each day consisting of two loops. Day one and Day two race end time will be the final control flying finish times of each competitor. Elapsed times will be calculated as Day end time minus Day start time of each competitor. Refer SSR 306 [i]. The elapsed times including time penalties will be classified from shortest to longest. This will be the competitor's classification for the day. Protests received disputing the classifications of Day one will be heard by the Stewards of the meeting, and their final decision will determine the starting order for Day two. **DNF** in Day one loop 2 will be allocated a start position for Day two loop 3 as per SSR 311 [iv], including time penalties. The sum of the elapsed times for Qualifying, Day one and Day two, will be classified from shortest to longest. This will be the competitor's classification for the Marathon event.

The Marathon category and class winners will be declared on the shortest main race time including time penalties plus qualifying race time including time penalties in the respective category and class.

Refer SSR 306 [i], 314 [i], [iii] and [iv].

[iv] Time Back:

Time back may be considered under certain extreme circumstances if a competitor is held up in some unforeseen instance where the route is temporarily blocked through human error, eg. locked gates, farm implements travelling to place of work, purposeful blocking of the road by outsiders, etc. It does NOT include

Force Majeure - flooding rivers, rock falls, blown over trees, etc. It does NOT include mechanical failures, nor driving or navigational errors.

The onus is entirely on the competitor to prove time lost, by presenting visual evidence from in-car camera footage of the blockage. The footage must be from the cab facing the road, with car competition number visible on the dashboard, camera time and date stamp, GPS pin, and road book distance and instruction number. External camera footage may also be accepted provided the car is clearly identified as well as the time and date and the GPS pin. RallySafe will be used to determine the time lost, if any.

Time back will be considered by and at the sole discretion of a jury consisting of the Clerk of the Course, Timing and Tracking Manager and the Competitor Relations Officer. This Time Back request must be lodged within thirty (30) minutes of completion of the qualifying race or the main race.

[v] **Tie Classification:**

For a dead heat, the competitor who finished the qualifying race in the higher position will be declared the winner.

[vi] **Race Time Bar:**

The Race Time bar will be advised at the time of posting the qualifying race classifications for the exclusion of slower competitors at the finish (as stipulated in the SR's, Final Instructions or any other Official Notice published by the organisers) and is recommended to be three (3) hours after the leading competitor finishes the event. This time bar may be changed by the Clerk of the Course of the event.

[vii] **DSP Time Bar:**

The time bar for the exclusion of slower competitors when exiting the DSP will be published at the time of posting the qualifying race classifications.

NOTE: Every competitor has the right to request to see any written or printed matter, records, timecards and sequence sheets etc. pertaining to their own vehicle on the event.

308.

NEUTRAL ZONES ON PUBLIC ROADS (formerly decontrols)

Where the route of an event follows an *open public road, or sensitive areas such as farm houses, race horse stables etc.*, competitors will be *neutralised* and given an **adequate** time allowance that will allow them to complete this section whilst obeying all normal road traffic rules. *Neutral zones may also be used as speed limit sections.* The outside assistance rule will be applicable in a *neutral zone*. Refer 318 A [xii]

i) Marshal operated Neutral Zones:

Competitors will be restarted in the same position and at the same time intervals as they arrived at the *marshal point at the beginning of the neutral zone*. Competitors arriving at the *marshal point at the end of a neutral zone* before their allocated start time *may* only restart at their allocated start time. Competitors arriving at the end of the *neutral zone* after their allocated start time will be restarted at such time and sequence as determined by the control official. No allowance will be made for any waiting time incurred by such a competitor. Refer SSR's 306 [i], [ii] and [iii]

ii) RallySafe operated Neutral Zones:

Neutral zones will be indicated by a Danger/ Caution board erected 200m before the neutral zone. A SN board will be placed at the stop point. The competitor must stop at the SN board, indicated by RallySafe as a stop point on the RallySafe screen as well as in the road book. The screen will indicate the time and distance countdown to the end of the Neutral zone. The competitor is required to *wait for the RallySafe screen to show "Speed Achieved"(zero) on a white screen*, and then continue on the *neutral zone. Leaving early will record a jump start on RallySafe.* The *neutral zone end (FN) stop control* point will be indicated on RallySafe, in the road book, as well as a *FN board* next to the road. **Do not pass the board before the restart time shown on the screen**, as the RallySafe pin is **10 to 20 metres** ahead. Once past the pin the RallySafe is activated and will record a jump start if early. *Not stopping at the SN board and early departure at the FN board* as indicated on RallySafe will carry a penalty of ten minutes. *Competitors are required to stop whether the sign boards are present or not, using RallySafe and the road book.* Refer SSR's 306 [i], [ii], [iii], SSR 309, SSR 318 A [iv] a) and b), and SSR 318 A [viii] o)

iii) Speed:

The time between Neutral Zone start and Neutral Zone finish will be calculated to an average speed which is lower than the posted speed limit. It is therefore not necessary to exceed the posted speed limit. Speeds exceeding the posted speed limit on RallySafe and/or the general maximum speed limit will be penalised by the Clerk of the Course. The speed limit control will be done by RallySafe which is the category definitive speed control. The speed recorded by RallySafe will not be contestable. The RallySafe will generate a rolling average to remove spikes in the collected speed data. The data recording frequency

and period may be altered to suit different routes. The recorded averages may not exceed the speed limits applicable.

Refer SSR's 318 A [jii] a)

- iv) Competitors may not speed to gain time for repairs in a *neutral zone*. Should competitors be delayed for any reason, it will be in their race time as the RallySafe time will commence as indicated. Competitors late at the end of the *neutral zone* will start on arrival, but due care must be taken not to block competitors who are on time. Refer SSR's 315 [jii] and [iv].

309.

ROAD CROSSINGS, RAILWAY CROSSINGS

- i) Where the route crosses a road or railway line, *a danger/caution board must be erected 200m before the stop point. A board with a black cross on a white background must be erected 100m before the stop point. Two Stop boards must be erected at the stop point, one on either side of the route. The competitor must stop before reaching the boards, also indicated as a stop point on the RallySafe screen and road book. It is compulsory to stop where indicated. The whole vehicle must stop before an imaginary line drawn between the two stop boards. **Stopping in the middle of the road or right across is not safe.** A stop is defined as a vehicle being stationary, and not sliding with locked wheels. Taking a board/s out, will be regarded as not stopped. Having stopped, the competitor may move forward between the boards. The onus is on the competitor to ascertain whether it is safe to cross the road/railway line. The organisers may use cameras at stop points to monitor stops. The Clerk of the Course's decision on the safety of the vehicle's stop is not contestable. Should a Neutral Zone start coincide with a cross roads or a railway crossing, SSR 309 takes precedence in terms of the stopping and safe road crossing procedure. However, the competitor still has to wait for the RallySafe countdown on the screen before moving forward between the stopboards. Leaving early will record a jump start. Where a road/rail crossing coincides with a Start Neutral Zone, there will be no SN boards. Only the stop boards. Refer also SSR 306 [ij]. No overtaking in a control area.*
- ii) Organisers must ensure that all Stops are shown in the Road Book and on RallySafe. *Unused railway lines will be indicated as **inoperative** in the road book and on RallySafe. Active lines will have a stop in the road book and RallySafe.*
- Competitors are required to stop whether the Stop boards are present or not. Competitors who ignore the instruction in the Road Book or on RallySafe will carry the same penalty as if the Stop boards were in place. For contravening the road and rail crossing regulation the penalty is 10 minutes for each transgression. Refer SSR 318 A [iv] b) Transgressing more than three times during an event will result in exclusion. Refer SSR 318 A [viii] o).

310.

PRE- AND POST-RACE PADDOCK, DSP AND PARC FERMÉ

[i] a) Pre-Qualifying Line up

Competitors must personally present their competition vehicle into a pre-qualifying line up, and be past the Line-Up board a minimum of thirty (30) minutes prior to their start time for qualifying. Failing to comply will incur a five (5) minute penalty plus the time late into line-up. Refer SSR 318 A [jii] b). One of the competitors must remain with their vehicle whilst in the pre-qualifying line up. Refer SSR 318 A [jii] a). Parc Fermé rules apply after the vehicle has entered the control area as recognisable by the M board.

b) Qualifying Start

Competitors not on the start line at their starting time will start at the back of the field as determined by the start officials incurring a fifteen (15) minutes penalty. Refer SSR 318 A [v] b).

c) Pre-Race Line up

Competitors must personally present their competition vehicle into a pre-race line up, and be past the Line-Up board a minimum of thirty (30) minutes prior to their start time for the main race. Failing to comply will incur a five (5) minute penalty plus the time late into line-up. Refer SSR 318 A [jii] b). One of the competitors must remain with their vehicle whilst in the pre-race line up. Refer SSR 318 A [jii] a). Parc Fermé rules apply after the vehicle has entered the control area as recognisable by the M board.

d) Race Start

Competitors late at the start line will wait on arrival and start as instructed by the start official incurring a fifteen (15) minute penalty. The competitor's race time will start as per the published time. Refer SSR 318 A [v] c). No time compensation will be given.

e) GPS and RallySafe Activation

These units MUST be powered up and operational a minimum of thirty (30) minutes prior to the competitor's start time. Failing to power up and activate the GPS and RallySafe units and reset the Data Logging

equipment will incur a Five (5) minute penalty. Refer SSR 318 A [iii] g)

NOTE: Do not drive in the vicinity of the start line in the DSP. The RallySafe start pin will be activated within 20 metres, and/or above 20km/h. The RallySafe will be logged as a jump start and will also not count down the start time, as it is already started.

[ii] Compulsory DSP Stop

After loop one/two/three for events as per SR's, competitors will enter the compulsory 30-minute DSP service stop. The service time will start from the flying finish time as entered on the Time Card. The Time Control will double up as the DSP-in Time Control. Should this be preceded by a Decontrol section, the Decontrol End will double up as the DSP-in Time Control.

The service allowance *ends at the DSP-out Time Control. For all races*, competitors will exit DSP on the exit time indicated on the timecard. Late exit out of DSP will be added to loop two/three/four race time. No compensation for late out of DSP. The DSP-out Time Control may also double up as the loop two/three/four start control.

In the case of a neutral zone section to the start of loop two/three/four, the competitor will leave the DSP exit on the allocated DSP exit time and drive to the loop start control to start on the allocated loop start time. The RallySafe clock will start at the competitor's allocated start time at the loop start. No compensation for lateness. Speed limits to be observed. Refer SSR 318 A [ii] a)

The DSP layout map will indicate the traffic flow direction which must be strictly adhered to. *For* contravening *competitor* traffic flow direction in DSP, refer SSR 318 A [iii] d).

[iii] Parc Fermé

There will be a post-race Parc Fermé at the finish of the event into which all competition vehicles must be placed. Release from the Parc Fermé will be subject to the discretion of the Clerk of the Course. GCR 252 [i] to [vii] is applicable. Refer SSR 318 A [viii] l).

At the end of each racing section competitors must report directly from the stop control to the impound based at the entrance to Parc Fermé for the purpose of GPS and/or RallySafe download and any technical check which may be required. Competitors will only be allowed in the Parc Fermé with the permission of the Technical Delegate or the DSP Marshal. Refer SSR 318 A [v] j) and GCR 252.

Parc Fermé will be restricted to competition vehicles. Only officials directly involved with Parc Fermé such as Control marshals, Timing and Tracking Officials, Scrutineers, accredited members of the media and camera crew, and MSA appointed officials may enter. Parc Fermé. Refer SSR 318 A [viii] m).

311. SERVICE CREWS/OUTSIDE ASSISTANCE

[i] The outside assistance rule commences at the start of the race after the vehicle has passed the M board at the entrance to the start control, and cancels at the DSP stop control, or the day's final stop control.

[ii] Passing food, drink and information by two-way radio, cell phone or in writing to or from the vehicle is permitted anywhere along the route and by any person except from aerial observation. This is provided that in doing so the passing of information does not create a situation which interferes with the passage of other competitors and/or the control point.

[iii] Outside assistance is not permitted from anyone other than from another competitor who is still competing. The crew may repair the vehicle on route with what is carried on board their race vehicle, or from an assisting competitor's vehicle.

a) Competitors who have completed the event are not permitted to give assistance.

b) The issue to, or receipt by the competitors of any manufactured materials (solid or liquid), spare parts, tools or equipment is not permitted outside authorised service parks or where specified as per the Road Book.

c) The transfer of electronic data related to any of the competing vehicle's operating systems to or from the vehicle by any means whatsoever is not permitted outside authorised service parks or where specified as per the Road Book.

d) A competition vehicle causing an obstruction or blocking the route may be removed with outside assistance or by another active competitor only to such a point where the route is clear and safe passage has been obtained, or the vehicle has been freed. No competing vehicle may be towed by any vehicle on the route for any distance other than to remove and clear to safety, or it will be penalised as outside assistance.

The penalty for outside assistance is five (5) hours added to overall race time. Refer SSR 318 A [xii].

[iv] A competitor may not drive the vehicle back to DSP for repairs and assistance and then re-join the race route and continue racing. Refer SSR 305 [i]. A vehicle breaking down and which can be recovered safely

with the written permission of the Clerk of the Course may be repaired, and rejoin from the DSP before DSP out cut-off time.

Vehicles breaking down in loop 1 of Standard Event, One Day Event, Marathon Event and also loop 3 of Marathon Event may restart loop 2 and 4 from the DSP. Vehicles breaking down in loop 1 of Day one and loop 2 of Day two in Super Events may restart loop 2 from the Day two start line or loop 3 from the DSP. Restart will be in a specific start position as decided by the Clerk of the Course, Timing and Tracking Manager and the Competitors Relations Officer and communicated in writing.

DNF and restarting a next loop will carry a penalty of ten (10) hours. Refer SSR 318 A [xiii].

A competitor re-joining and completing a loop before race cut-off time will earn full points for classification including the time penalty.

- [v] A broken down vehicle may NOT be recovered from the race route without the written permission of the Clerk of the Course, or until after the route has been officially closed by the Clerk of the Course. Refer SSR 318 A [xi] b) and 318 C [i] a)

Should outside assistance be called in, and found on the race route, the Clerk of the Course will decide on a severe penalty, which may include a race ban in terms of SSR 318 C [i] a)

- [vi] One crew member must remain with the vehicle at all times to ensure a veldfire does not start and spread, and to remain in contact with crew or race control. Refer SSR 318 B [i] a)

312. PRE-RACE PRACTICING AND RACE AERIAL OBSERVATION

- [i] No route reconnaissance by whatever means will be allowed at any time during the sixty (60) days preceding the event. The foregoing, however, does not apply to legitimate participation in an event which may cross or use sections of the route within the sixty (60) days preceding the event. All decisions in this respect shall be referred to the Clerk of the Course. Refer SSR 318 [viii] b).

- [ii] Aerial observation of the race route and/or race vehicles from aircraft, including drones, and air to ground communication between observers and car crews is strictly forbidden during races. Aerial photography may be allowed with the written permission from the Clerk of the Course subject to the prevailing laws and Civil Aviation Authority. Refer SSR 318 A [viii] a).

313. YELLOW/WHITE LIGHT

- [i] Organisers are required to have a minimum of one (1) checkpoint on each section of an event, to check that yellow and white lights on competition vehicles are operational. Refer SSR 306 [iv] a)

Failure to repair a yellow light immediately after being instructed to do so by an official or marshal whilst racing without a yellow light will incur a penalty of exclusion and the competitor will be prevented from racing any further. Refer SSR 318 A [viii] q).

Failure to repair a white light immediately after being instructed to do so by an official or marshal whilst racing will incur a penalty of fifteen (15) minutes. Refer SSR 318 A [v] a)

314. STARTING ORDER

- [i] **Qualifying race**

The qualifying race for a national championship event will be run in conjunction with the National seeding system and starting order established by the CEO of *SA Rally-Raid Championship*, the Clerk of the Course and the Timing and Tracking Manager. The starting order will be according to the National Overall Seeding List.

The *start* gap between the competitors for the start of the qualifying race will be as specified in the event SR's. The *start* gap between competitors can be changed by the Clerk of the Course in consultation with the Timing and Tracking Manager, Competitor Relations Officer and CEO of *SA Rally-Raid Championship for all races* if deemed necessary.

Unseeded drivers will be given a starting position agreed to between the Clerk of the Course, the Timing and Tracking Manager and the Competitor Relations Officer, based on safety considerations.

- [ii] **Reserved.**

- [iii] **Main Races Loop One**

Standard Event, Super Event, One Day Event and Marathon Event.

The *loop one* starting order for main races and Marathon Day one racing will be determined by the classification established in the qualifying race. *The top ten (10) drivers classified in the qualifying race will be able to choose their start positions in loop 1 in a draw, with the tenth classified driver having first choice, then the ninth and so on. Start positions may be knocked down by subsequent driver choices. Should the lower positions all be taken, the position will be knocked up, e.g. the driver classified first wants to start third,*

but only position one is still vacant, drivers in position two and three will be knocked up to positions two and one.

The same applies to the lower positions. Should all the lower positions be filled, the knock will take place pushing upwards.

Competitors who started but did not finish the qualifying race will be started behind those who finished, in the sequence determined by their national seeding order. Competitors who entered but did not start the qualifying race will be started behind those who started but did not finish, in the sequence determined by their national seeding order. The starting gap between cars will be a minimum of two (2) minutes. The gap may be amended by the Clerk of the Course in consultation with the Timing and Tracking Manager, Competitor Relations Officer and CEO of the *SA Rally-Raid Championship* if conditions warrant it.

[iv] Super Event:

The starting order for Day two will be determined by the classification established in Super Event day one.

Refer SSR 314 [iii]

DNF in loop *one* will be allocated a start position for Day two loop *two* as per SSR 311 [iv], including time penalties.

[v] Marathon Day Two:

The starting order for Day two will be determined by the classification established in Marathon Day one.

Refer SSR 314 [iii]

DNF in *day one loop two* will be allocated a start position for Day two loop *three* as per SSR 311 [iv], including time penalties.

[vi] SA Rally-Raid Championship National Seeding System.

The National Seeding System is used to determine starting orders for the qualifying race and main races:

- a) Seeding system only uses real qualifying race times as recorded on the official timing system without penalties.
- b) Qualifying times from the last 24 months will be taken into account.
- c) The best four times of each competitor will be taken into account.
- d) If a competitor has less than four qualifying times his/her average will be calculated on those times.
- e) *If a competitor has only one qualifying time, he/she will be seeded behind the competitors in d), unless the competitor has a previous lapsed seeding in which case the Clerk of the Course, Timing and Tracking Manager and the CRO may determine his/her starting permission.*
- f) Each competitor's qualifying race time will be calculated as a percentage of the leading competitor's overall race time to a % with the ideal being 100%, and then compare each competitor's time to the leader assigning a % score.
- g) If an international competitor with an FIA Seeding enters the National Series the CEO *the SA RALLY-RAID Championship*, the Clerk of the Course, the Timing and Tracking Manager and the *Competitor Relations Officer* will determine his/her starting position.
- h) *First time competitors will start behind competitors in e) as determined by the, Clerk of the Course, Timing & Tracking Manager and the CRO. First time competitors with different category experience may be allowed to start somewhat higher in a position determined by the Clerk of the Course, the Timing and Tracking Manager and the Competitor Relations Officer.*

315. OVERTAKING/BUMPING

- [i]** Overtaking fellow competitors in Motorsport is a given. Unsportsmanlike behaviour will not be tolerated. Bumping and barging is forbidden.
- [ii]** Reserved.
- [iii]** Intentionally blocking another competitor is strictly forbidden. It is the duty of every competitor to recognise when another competitor has caught and is trying to overtake, and to allow them to do so at their earliest convenience.
- [iv]** Unsportsmanlike behaviour in the form of intentionally blocking and preventing overtaking, or bumping and/or ramming a competitor must be reported to the Clerk of the Course on an Incident Report Form. The reporting competitor must be accurate on the incident form regarding the location and duration of the incident. Road Book instruction number and/or accurate distance must be supplied. Vague information or deliberate exaggeration will result in the incident not being investigated. Refer SSR 318 A [v] h), [viii] c) and SSR 318 B [i] f).
- [v]** The Clerk of the Course may call for and scrutinise individual competitors' in-car camera footage, external

cameras as well as GPS and/or RallySafe units to establish whether any transgression of the rules are apparent by the competitor/s. The onus is on the competitor/s to prove innocence, and should clear evidence not be available to prove innocence, the Clerk of the Course will apply the specified penalty. Refer SSR 318 A [viii] c) and SSR 318 B [i] f).

[vi] RallySafe push-to-pass:

The maximum distance between vehicles where the RallySafe can be activated will be set at **200** meters. This distance may be reset by the Clerk of the Course in consultation with the Route Director and the Competitors Relations Officer.

- a) *When a competitor is "buzzed" he should anticipate to allow an overtake opportunity as soon as terrain conditions warrant it.*
- b) *After a maximum of three "buzzes" within a 5 km distance by the following competitor, the leading competitor is obliged to move over within 500 meters after the third buzz. Should this not happen, the Clerk of the Course may apply the penalty for not moving over, and this may include exclusion. The "buzzes" and distances will be verified by RallySafe. Refer SSR 315 [iv] and SSR 318 A [v] h) and 318 B [i] f)*

316. REFUEL

[i] Refuel points shall be a maximum of three hundred (300) kilometres apart.

[ii] a) Under normal circumstances refuelling will take place at the *on site* fuel pumps in the DSP.

b) During race conditions refuelling will take place in the allocated DSP pit. The following precautions shall be taken:

- the vehicle must be switched off at the battery cut-out switch for the duration of *refuelling*.
- no person may be seated in the vehicle during the refuel process.
- the two pit fire extinguishers shall be placed close at hand on either side of the vehicle during *refuelling*.
- when refuelling, an anti-static line shall be connected to the vehicle chassis and to a steel or copper peg in the ground. Good electrical contact must be ensured.

c) Each refuel pit shall be equipped with two (2) handheld DCP (dry chemical powder) fire extinguishers with a minimum capacity of 4,5 kg powder each. These extinguishers shall be certified for Class A, B and C fires and conform as a minimum to SABS 1910 for the bottle and SANS 1522 for the powder.

Each handheld extinguisher must be equipped with a pressure gauge to check the pressure of the contents. The following information must be visible on each fire extinguisher:

- Capacity
- Type of extinguishant
- Weight or volume of the extinguishant
- Date the extinguisher must be checked which must be no more than one (1) year after either date of filling or the date of the last check corresponding expiry date.

d) Environmental mats are compulsory at ALL refuel points at the designated route refuel points, including DSP.

The *SA Rally-Raid Championship* will provide smaller environmental mats to be used in Parc Fermé and Holding areas if and when required. Refer SSR 318 A [vi] c) and d).

[iii] The organisers must appoint a Safety Officer who will observe the refuel procedure and who may report any infringements on the refuelling regulations to the Clerk of the Course for disciplinary action. The penalty is thirty (30) minutes. Refer SSR 318 A [vi] f)

[iv] Empty fuel drums must be removed from the refuel area/DSP by the competitor's service crew. Appendix 3 – Fuel Storage & Safety: Article 1.2 of the MSA Environmental Code Refers. Failure to comply with this requirement will result in a fine as detailed in SSR 318 A [x] f).

[v] *Remote refuel zones and limited remote servicing may be incorporated should loop distances require such.*

317. ACCIDENTS/USE OF MEDICAL WARNING BOARD/INCIDENTS/RETIREMENTS/MISDEMEANOURS

[i] Accidents

Should a competitor happen upon a scene of an accident/vehicle stopped at the side of the route where no medical warning board is displayed, it must be assumed that the injuries are of such a nature that the competitors concerned are seriously injured and unable to display the medical warning board. Assistance must be rendered immediately. Should further assistance from other competitors be required, the competitors of the vehicle

rendering the initial assistance must display their medical warning board with the red cross clearly visible to oncoming competitors.

Should no further assistance be required, the green "O" or "OK" should be displayed. Once the injured competitors have been assisted, their medical warning board should be displayed with the green "O" or "OK" clearly visible to oncoming competitors until such time as the vehicle has been removed from the route.

DO NOT move the injured person unless he/she is in a dangerous position. THE NEXT MARSHAL MUST BE INFORMED AS SOON AS POSSIBLE IN ORDER TO SUMMON ASSISTANCE. PLEASE GIVE THE MARSHAL THE INJURED PERSON'S LOCATION (GOOGLE MAP PIN), NAME (WHERE POSSIBLE) AND COMPETITION NUMBER (WHERE APPLICABLE). WHEN AN AMBULANCE IS ENCOUNTERED ON THE ROUTE, IT HAS THE RIGHT OF WAY AT ALL TIMES.

A second Medical "Board" which will be of a cloth nature and with eyelets in each corner must be carried in the vehicle. This must be attached to the top of the stationary vehicle so that it is visible from overhead. This is to help with possible aerial evacuation or assistance being given. A penalty of one thousand Rand (R1 000.00) will apply for not complying with this instruction.

[ii] Use of the Medical Warning Board

- a) Should any competitor stop due to being involved in an accident whilst on the route being used for an event, the two (2) medical warning boards together with a warning triangle must be displayed. This also applies to any vehicle stopped on the side of the route due to mechanical or any other failure. Competitors are reminded of the importance of displaying the OK board when they are stopped and thereby ensuring that the status of the "stop" is clear to all concerned.
- b) Should medical assistance be required, the medical warning board must be displayed in such a manner that the red cross is clearly visible to oncoming competitors, preferably at eye-level. Care must be exercised to ensure that the correct side of the board is displayed to oncoming competitors. While the medical warning board is displayed in such a manner that the first competitor arriving on the scene of an accident must stop and render assistance, however, should this not be possible you must display the distress sign by holding both hands in triangular shape above your head and jump up and down to attract on-coming competitors' attention.
- c) Reserved
- d) Following an accident or where a vehicle is stopped at the side of the route and no assistance is required, the green "O" or "OK" must be clearly displayed to oncoming competitors until such time as the vehicle has been removed from the route.
- d) Competitors who fail to stop on arriving at the scene of an accident, where no medical warning board is displayed or where the red cross is displayed, are guilty of contravening the regulations and will be excluded. Refer SSR 318 A [viii] n).
- e) Competitors who are not injured and who leave a vehicle on the route and fail to display the green "O" or "OK" shall be subject to a fine. Refer SSR 318 A [x] g).
- f) Misuse of the medical warning board will be treated as a serious offence and will be dealt with accordingly.
- g) Competitors who render assistance may be compensated for the time they have spent at the scene using information from their GPS/RallySafe device and other electronic devices. Should electronic information not be available for whatever reason, the time compensated will be calculated by taking interval to another competitor most closely matched in speed at various controls e.g. if the competitor is running at roughly the same speed as another competitor, it can be reasonably assumed that the time gap between them would have remained the same at the next control and the difference between the expected time and the actual time to be returned to them.

A competitor who is involved in an accident where medical assistance is required by that vehicle's crew and is then able to continue racing may not claim compensation.

[iii] Incidents

- a) Competitors will be issued an Electronic Incident Report Form by GPS officials after each day's racing (qualifying race, Day 1, Day 2 and Day 3). All timing equipment to be returned. *Refer SSR 318A [xi]-2). [x] a)*
- b) Competitors who retire from the event must still complete the Electronic incident report form and return all timing equipment. *Refer SSR 318A [xi]-2). [x] a)*

- c) Any incidents involving any person or property must be reported on the Electronic Incident report form(s). The link for these are available from the link on the Telegram virtual notice board. These must be completed daily before the stipulated cut off time. In particular, competitors must notify the organisers of any damage/broken fences/gates/crops so that the necessary repairs may be carried out. Should a competitor fail to report any incident of this nature on this form, that competitor will be reported to the Clerk of the Course and a fine of Rand four thousand (R4 000.00) will be imposed. Refer SSR 318 A [xi] c).
- d) Should a competitor not be able to present the GPS or return the timing equipment before the end of the event due to a vehicle not yet recovered back to DSP, then the onus is on the competitor to make arrangements with GPS officials BEFORE the end of the event to get the GPS data and return the timing equipment ASAP. Refer SSR 318 A [xi] a).
- e) In exceptional circumstances competitors race times may be amended for incidents where they were delayed due to veld fire or similar, by a Jury comprising the Clerk of the Course, Competitors Relations Officer and the Timing and Tracking Manager.
- f) Competitors may be requested to present their GPS for download if there is insufficient data from the timing system. This will be done on a case by case basis.

[iv] Retirements

Any competitor retiring from the event should notify race control as soon as possible. This can be done in a number of ways: -

- a) Advise the nearest radio marshal/marshal/official – ask them to relay this to race control.
- b) Call the secretary of the event and advise him/her that you are retiring.
- c) Report immediately to GPS to download on return to DSP.
- d) Information to be reported is:
 - Competitor Number
 - Need assistance getting back or can make it back on own.
 - Reason why retiring.
- e) Any competitor who fails to notify race officials by means of the incident form within one (1) hour of returning to DSP will be subject to SSR 318 A [x] a) and c).
- f) If unable to return to DSP before the end of the racing section, the onus is on the competitor to have a team member come to race officials and report this fact. They are also to arrange with GPS officials for return of any equipment and GPS download information outstanding.

[v] Misdemeanours

Penalties for misdemeanours or transgressions of the rules discovered during or after an event regarding damage to property, but not limited to, may be applied after the event. Refer SSR 318 A [v] i, [vi] b), e, and [xi] e) **a) and b)** After each round of the *SA Rally-Raid Championship* and finalisation of all formalities and classifications of the race, the Timing and Tracking Manager may download and scrutinize individual competitor's data logs to establish whether a misdemeanour of any sort or any transgression of the rules is apparent by a competitor. This will be brought to the attention of the Officials of the event so that appropriate action may be taken if deemed necessary. If it is discovered and proven that a competitor transgressed the rules, the Clerk of the Course of the meeting may impose a time penalty on the guilty competitor for the NEXT round of the *SA Rally-Raid Championship* in which they enter and compete. This time penalty will be added to the main race time of the competitor on his/her next event. The first offence or transgression related to damage to property will carry a time penalty of fifteen (15) minutes. The second infringement will carry a penalty of (30) minutes. For three (3) or more infringements, a one (1) race ban could be imposed.

The Clerk of the Course may call for, and scrutinise individual competitors' in-car camera footage, external camera footage, as well as Data Logger tracking after an event to establish whether any transgression of the rules was committed by competitors. The onus is on the competitor to prove innocence, and should clear evidence not be available to prove innocence, the Clerk of the Course will apply the specified penalty. Competitors will be advised of any pending penalty immediately it is discovered after a race and will be entitled to view all relevant material, including data logger printouts, on-board and external camera footage, photographs or similar at a hearing at an agreed-to time and place, where the penalty may be imposed. Competitors' normal rights of protest and appeal apply.

318. PENALTIES

- A. The following timing penalties will be imposed by the Clerk of the Course in consultation with the Competitor Relations Officer and where such penalties are applied, it shall not be necessary to hold a hearing with competitors. Refer GCR 157.
- [i] Reserved.
 - [ii] **Two (2) Minutes**
 - a) *The penalty for exceeding the RallySafe averaged speed limit is two minutes for every transgression. The Clerk of the Course may impose stricter penalties in the case of repeat offences. Refer SSR 303 [v] and 308 [iii]*
 - b) Cutting corners marked by corner markers indicating the inside *and/or outside* of the corner. Penalty for flattening the marker, taking the marker out, passing on the inside/*outside* of the marker. Two minutes penalty for each marker. The *Clerk of the Course* may increase the penalty for more than three incidences. Refer SSR 305 [iv].
 - [iii] **Five (5) Minutes**
 - a) For at least one crew member not remaining with the vehicle in the qualifying or pre-race line up. Refer SSR 310 [i] i) and iii).
 - b) For not reporting to the Start official of the pre-qualifying line up and pre-race line up thirty (30) minutes before their allocated start time. Refer 310 [i] i) and iii).
 - c) For the minor category of deviation of the route, on recommendation of a jury comprising the Clerk of the Course, Timing and Tracking Manager and the Competitors Relations Officer. Time advantage gained to be added to the penalty. Refer SSR 300 [x] b) and SSR 305 [ii] a).
 - d) Contravening traffic flow direction in DSP. Refer SSR 303 [iii].
 - e) For failing to report times at a *neutral zone* official which may include DSP controls. Refer SSR 306 [iii].
 - f) For non-attendance of the crew at competitors briefing. Refer SSR 300 [xi].
 - g) For failing to activate and reset the GPS and RallySafe data Logging equipment. Refer SSR 310 [i] v).
 - [iv] **Ten (10) Minutes**
 - a) For early departure of competitors from Designated Service Points (DSP's) and any other start control during the event, the following penalty will apply:
Early departure at the Time control defining the exit of the compulsory stop will entail an automatic ten (10) minute penalty. The time difference between the allowed time and the actual time taken (the time by which early departure took place) will be added to the ten (10) minute penalty. Refer SSR 306 [i], [iii] and 308 [ii].
 - b) For not stopping as per SSR 308 [i],[ii] and 309 [iii]
 - c) For not stopping at a Light Check Control or ignoring a control official's instruction. Refer SSR 306 [iv] a
 - v] **Fifteen (15) Minutes**
 - a) For being unable to repair a white light when instructed to do so by a Light Check Marshal or any other official. Refer SSR 313 [i].
 - b) For contravening SSR 310 [i] ii) pertaining to start time. (qualifying race).
 - c) For contravening SSR 310 [i] iv) pertaining to start time. (main racing section).
 - d) For contravening SSR 301 [iv] pertaining to Medical Board and Warning Triangle.
 - e) For contravening SSR 306 [ii] pertaining to the procedure at Timing Controls.
 - f) Reserved.
 - g) For the major category of deviation of the route on recommendation of a jury comprising the Clerk of the Course, Timing and Tracking Manager and the Route Director plus time advantage gained. Refer SSR 300 [x] b) and SSR 305 [ii] b).
 - h) For failing to allow overtaking and/or intentionally blocking those trying to overtake. Refer SSR 315 [iv] and [vi].
 - i) First offence for misdemeanour or transgression in terms of SSR 317 [v].
 - j) For contravening SSR 310 [iii]. Trespassing in Parc Fermé.
 - k) For contravening National and Local traffic regulations. Refer SSR 303 [vi]
 - [vi] **Thirty (30) Minutes**
 - a) Reserved
 - b) For interfering with, turning off or otherwise preventing timing and tracking devices from performing as designed. Refer SSR 317 [v].
 - c) Non-use of environmental mats in the DSP area. Refer SSR 316 [ii] iv).

- d) Non-use of environmental mats by vehicles at the designated route refuel points. Refer SSR 316 [ii] iv).
 - e) Second offence for misdemeanour or transgression in terms of SSR 317 [v].
 - f) For contravening the refuelling procedures and regulations. Refer SSR 316 [iii]
 - g) *Reserved*
- [vii] Sixty (60) Minutes**
- a) Reserved
 - b) For missing, failing to stop at a Route Check/Timing Control or complete a timecard and/or hand the timecard to the controller or ignoring a control official's instruction. Refer A 306 [i], [iii] and SSR 308.
 - c) *Reserved.*
 - d) For failure to complete documentation and/or scrutineering by the closing times stipulated in the SR's. Refer SSR 300 [vii] b).
- [viii] Exclusion**
- a) For aerial observation of race vehicles from aircraft, and air to ground communication between observers and car crews whilst racing. Refer SSR 312 [ii]
 - b) For having been found to have practiced on or in the vicinity of the route within sixty (60) days preceding the event. Refer SSR 312 [i]
 - c) For bumping or ramming a competitor. Refer SSR 315 [v].
 - d) For failure to wear a helmet while racing and non-compliance to the crash helmet requirement and for failure to have the safety harness properly fastened at all times whilst in a moving vehicle. Refer SSR 300 [vii] a).
 - e) For failure to obey the Route Direction and Route Deviation. Refer SSR 305 [i] and [iii] and SSR 306 [ii]
 - f) Reserved
 - g) For finishing an event with a different chassis or engine block number to that fitted to the vehicle when scrutineered. Refer SSR 301 [v].
 - h) Reserved
 - i) For failure to have Garmin GPS and RallySafe devices fitted as instructed and operational. Refer SSR 300[x] h).
 - j) For failure to carry out the instruction of an official.
 - k) For carrying fuel in loose containers in a competition vehicle. Refer SSR Part 2 Art 7.4
 - l) For failure to place a vehicle in the Parc Fermé on completion of the event. Refer SSR 310 [iii].
 - m) For entering a Parc Fermé i.e. post-race by the crew or service crew without the Clerk of the Course's permission, except when placing the vehicle in or moving the vehicle from such a holding area, may lead to exclusion at the discretion of the Clerk of the Course. Refer SSR 310 [iii].
 - n) For failure to comply with the provisions of SSR 317 [i] or [ii].
 - o) For contravening the Road and Rail Crossing and *Neutral Zone* regulation three (3) or more times. Refer 308 and 309.
 - p) For contravening SSR 300 [vii] b) pertaining to protective clothing.
 - q) For failure to repair a yellow rear dust light. Refer SSR 313 [i]
- [ix] Rand five hundred (R500.00) Fine**
Refer failure to produce the technical passport on request.
- [x] Rand one thousand (R1 000.00) Fine**
- a) For failing to hand in/submit an Incident Report Form within one (1) hour of completion of, or retirement from, each days racing. Refer SSR 317 [iv] e).
 - b) Reserved.
 - c) For failing to complete the Incident Report Form in full. Refer SSR 317 [iv] e).
 - d) Reserved.
 - e) Reserved.
 - f) For failure to remove empty fuel containers. Refer SSR 316 [iv].
 - g) For failure to display "O" or "OK" board of a stranded vehicle left on the route. Refer SSR 317 [ii] f).
- [xi] Rand four thousand (R4 000.00) Fine**
- a) For failing to report to GPS to download at the end of or retirement from each days racing. In the event of being unable to report (crew and vehicle still being recovered), a team member must do this on behalf of the competitor. Refer SSR 317 [iii] d).
For receiving assistance to recover a vehicle on the route during the running of the event without the written permission of the Clerk of the Course. Refer SSR 311 [v].
 - b) For failing to report any damage/injury to property or persons to the Organisers on the completed Incident Report Form. Refer SSR 317 [iii] iii) and [v].

[xii] Five (5) hours

For receiving outside assistance other than from a competitor still competing. Refer SSR 311 [iii].

[xiii] Ten (10) hours

For failing to complete loop 1/2/3 and re-joining loop 2/3/4. Refer SSR 311 [iv]

B. Penalties may be imposed in respect of contravening any of the items listed below by the Clerk of the Course in consultation with the Competitors Relations Officer, and subject to a hearing being held in terms of GCR 175.

- [i]**
- a) For abandoning a stranded vehicle and not maintaining communications with Race Control.
 - b) For smoking whilst racing.
 - c) For driving dangerously or without due consideration to other road users.
 - d) For allowing a person not in possession of a valid driver's licence/valid competition licence to be in control of a vehicle during competition.
 - e) For carrying any unregistered passengers other than stranded competitors or officials.
 - f) For failing to afford the opportunity to overtake or deliberately preventing overtaking.
 - g) For contravening any traffic rules or regulations.

C. Penalties which may be imposed by the Clerk of the Course in terms of GCR 157.

- [i]**
- a) For behaving in a manner prejudicial to motorsport, bearing in mind that competitors are responsible for the actions of their service crew/s.
 - b) Committing any breach of the GCR's, these SSR's and the SR's or Final Instructions for which no specific penalty has been laid down.

319. **TEAM AWARDS**

A. Manufacturer's Team Award

- [i] The award will be made in Classes *FIA T1+*, *FIA T1*, *FIA T1.2*, T, S, D & E. The three highest finishers in category points from the same brand will be the winner of the Manufacturer's Team Award. Only two finishers in the top three may be from the FIA classes. The brand with the second highest category points will receive the next position followed by the brand with the third highest category points.
For the Overall Manufacturer's Championship, refer SSR 320.4
- [ii] In the event of there not being three (3) finishers from one (1) manufacturer, the award will not be made.
- [iii] The manufacturer's team manager/representative will be presented with a trophy for the winning manufacturers team and miniatures of the trophy will be presented to the drivers and navigators constituting the winning manufacturer's team.

B. Entrants Team Award

- [i] This award will be made to the highest placed two (2) vehicles from the same entrant in both *the Special and Procuton Vehicle* categories with the lowest aggregate time when added together. In the event of a tie, the team with the highest position finisher will win.
- [ii] In the event there not being two (2) vehicles from one (1) entrant, the award will not be made.
- [iii] The team entrant/representative will be presented with a team trophy and miniatures to the drivers/navigators constituting the winning team.
- [iv] Excluding a team/s who represent a manufacturer entry.

320. **CHAMPIONSHIP SCORING**

- 1. *2022* Championship Series
The *2022* MSA Motorsport calendar is available from MSA and gives details of the championship series.
- 2. Aims of the *SA Rally-Raid Championship*
To declare the following champions:
 - 2022 SA Rally-Raid Championship* Special Vehicle Category Champion Driver.
 - 2022 SA Rally-Raid Championship* Special Vehicle Category Champion Navigator.
 - 2022 SA Rally-Raid Championship* Production Vehicle Category Champion Driver.
 - 2022 SA Rally-Raid Championship* Production Vehicle Category Champion Navigator.
 - 2022 SA Rally-Raid Championship* Classes A, P, G, T, *FIA T1+*, *FIA T1* and *FIA T1.2* Champion Drivers.
 - 2022 SA Rally-Raid Championship* Classes A, P, G, T, *FIA T1+*, *FIA T1* and *FIA T1.2* Champion Navigators.
 - 2022 SA Rally-Raid Championship* Manufacturers Championship.**Refer SSR 320 2.2**

2.1 Categories:

A competitor's Category points will be used to determine his/her score in the respective Championships. Competitors with the highest number of points will be declared the Category Champions.

2.2. Classes:

A competitor's Class points will be used to determine his/her score in the respective Class Championships. Competitors with the highest number of Class points will be declared the Class Champions. Class Championships will only be awarded to Classes with an average of six (6) competitors or more during the season.

- 2.3 The classes will score towards the *SA Rally-Raid Championship* in respect of the number of starters as follows:

6	or more Starters	full points
5	Starters	from 2nd place
4	Starters	from 3rd place
3	Starters	from 4th place
2	Starters	from 5th place
1	starters	from 6th place

3. Points Scoring

3.1 National Championship one-day and two-day 400 km events:

The allocation of category and class points are as follows:

Position	Category	Class		Position	Category	Class
1st	30	30		9th	7	7
2nd	23	23		10th	6	6
3rd	18	18		11th	5	5
4th	15	15		12th	4	4
5th	12	12		13th	3	3
6th	10	10		14th	2	2
7th	9	9		15th	1	1
8th	8	8				

3.2 National Championship three-day Marathon events:

The allocation of category and class points are as follows:

POSITION	CATEGORY	CLASS		POSITION	CATEGORY	CLASS
1 st	45	45		14 th	11	11
2 nd	37	37		15 th	10	10
3 rd	31	31		16 th	9	9
4 th	27	27		17 th	8	8
5 th	24	24		18 th	7	7
6 th	20	20		19 th	6	6
7 th	18	18		20 th	5	5
8 th	17	17		21 st	4	4
9 th	16	16		22 nd	3	3
10 th	15	15		23 rd	2	2
11 th	14	14		24 th	1	1
12 th	13	13		25 th	0	0
13 th	12	12				

3.3 Starting Points.

Each competitor entering and starting an event will receive five (5) class points.

3.4 Separation of Ties.

In the event of a tie at the end of a season, the competitor with the greatest number of category and thereafter class wins will be declared the winner. If this does not resolve the tie, then the greatest number of seconds will count, failing which the third event and so on. If this is still ineffective the MSA Cross Country Racing Commission will declare the winner on such a basis, as it deems fit.

4. Manufacturer's Championship.

Aim of the *SA Rally-Raid Championship* Vehicle Manufacturer's Championship, Classes *FIA T1+*, *FIA T1*, *FIA T 1.2*, T, S, D and E:

To declare a *SA Rally-Raid Championship* Vehicle Manufacturer's Champion from the above classes.

4.1 Eligibility

The championship will be open to all motor manufacturers entering vehicles, which comply with Classes *FIA T1+*, *FIA T1*, *FIA T 1.2*, T, S, D and E for *SA Rally-Raid Championship* Motor Vehicles. No points will be scored by re

Engine vehicles. Refer SSR Part II: Art 2.3

4.2 Number of Events to Count

All events will count towards the Vehicle Manufacturer's Championship.

The Championship winner will be the Manufacturer with the highest number of points at the end of the season.

The allocation of points is based on the overall finishing order of the respective brands in every event.

4.3 Points Scoring

Points will be scored as per category in SSR 320.3.1 for National Championship one-day two-day 400 km events, and as per SSR 320.3.2 for National Championship three-day Marathon events.

4.4 Separation of Ties

In the event of a tie at the end of the season the manufacturer with the greatest number of accumulated points on the first event of the season will be declared the winner. If this does not solve the tie, then the greatest number of accumulated points on the second event will count, failing which the third event and so on. If this is still ineffective the MSA *SA Rally-Raid Championship Exco* will declare the winner on such a basis, as it deems fit.

SA RALLY-RAID CHAMPIONSHIP
PART 2: CLASSIFICATION AND VEHICLE
SPECIFICATIONS

1.	GENERAL REQUIREMENTS	33
2.	DEFINITIONS	33
3.	PERFORMANCE CONTROLS	35
4.	EXHAUST SYSTEMS	39
5.	WINDOWS, SAFETY NETS, MIRRORS, CUTTERS	40
6.	FIRE EXTINGUISHERS	40
7.	FUEL TANKS	40
8.	BATTERIES, LIGHTING. ELECTRICAL	41
9.	SAFETY BELTS	42
10.	SEATS AND SEAT MOUNTINGS	44
11.	CHASSIS AND SAFETY CAGE	46
12.	SPECIAL VEHICLE CATEGORY CLASSES	58
	12.1 GENERAL REGULATIONS	58
	12.2 RESERVED	58
	12.3 CLASS A	58
	12.4 CLASS B	59
	12.5 CLASS P	59
	12.6 CLASS G	60
13.	PRODUCTION VEHICLE CATEGORY CLASSES	64
	13.1 GENERAL REGULATIONS	64
	13.2 CLASS FIA T1	65
	13.3 CLASS T	65
	13.4 CLASS S	70
	13.5 CLASS D	75
	13.6 CLASS E	77
14.	ADDENDA	81

1. GENERAL REQUIREMENTS.

- 1.1 Part 2 contains all the Technical Requirements for *SA Rally-Raid Championship* cars in both the Special Vehicle and Production based categories.
- 1.2 Safety will always be a top priority with the Commission, and unsafe vehicles, at the sole discretion of the Technical Delegate will not be allowed to compete.
- 1.3 These regulations are written in terms of authorisation, therefore, what is not expressly authorised hereinafter is not allowed.
- 1.4 Before manufacturing the first unit of a new vehicle series, the manufacturer must receive the agreement in principle from the *SA Rally-Raid Exco* by submitting a specification and drawing of the proposed vehicle, including the Safety Cage. The *SA Rally-Raid Exco* reserves the right to accept or refuse the homologation or certification of a vehicle and Safety Cage, in accordance with the design prescriptions established by MSA and the FIA. If there are any deviations from these MSA regulations which have been agreed to for a specific vehicle, it must be clearly documented and signed by the CEO of the *SA Rally-Raid Exco*. The deviations must also be documented in the Vehicle Technical Passport.
- 1.5 In the case of Category Production Vehicles, the manufacturer must elect a model of a vehicle in the production range on which the competition vehicle will be based. The details of the model of vehicle will be entered in the Vehicle Technical Passport.

Model of vehicle:

Vehicles belonging to a production-series distinguishable by a specific concept and external general lines of the bodywork and by an identical mechanical construction of the engine and the transmission to the wheels, with the same wheelbase and the same cubic capacity. To qualify as a model, the vehicle should have been sold in *mass production* quantities in one year in commercial dealer outlets in South Africa.

In the case of Category Special Vehicles in Class FIA, the model of vehicle is not applicable.

- 1.6 Production Vehicles built before 1 December 2010 must comply with the 2010 MSA regulations.
- 1.7 Manufacturers intending to build vehicles for FIA controlled events must read the applicable FIA regulations, as all the requirements are not included in these regulations.
- 1.8 A vehicle of a lower class may be permitted to enter and compete in a higher class provided it complies with the lower class rules. Permission must be requested from *SA Rally-Raid Exco* prior to the event.
- 1.9 Commission Approved (C.A.) shall mean:
Specific components shall be submitted to the *SA Rally-Raid* Technical Committee for approval. The cost and specification of these components, if accepted, shall be communicated to all competitors and the components shall be freely available at a fixed price to any competitor for a minimum period of 12 months subject to exchange rate fluctuation only. Only components referred to in these regulations as "Commission Approved" shall be subject to the approval system. The supplier's details and component specification will be available from the *SA Rally-Raid Exco*.
- 1.10 A Category Special Vehicle is defined as a space frame tubular chassis vehicle with 4x2 transmission or a Side x Side Vehicle with 4x2 *CVT* or 4x4 CVT transmission.
- 1.11 **Deviations:**
Should a specific car not be able to comply with a regulation as published for a technical reason, the entrant may apply for a deviation to the rule, based on sound technical grounds. The application will be considered by the Technical Consultants (TC) in consultation with the *SA Rally-Raid Exco*, and if approved will be published as a deviation for all cars of the make/model. The TC's decision will be final.
- 1.12 **Dispensations:**
Should a specific car not be able to comply with the regulations as published for a temporary technical reason, such as parts unavailability, temporary crash repairs, etc, the entrant may apply for a dispensation, based on sound technical grounds. The application will be considered by the TC's in consultation with the *SA Rally-Raid Exco*, and if approved, will be published as a dispensation for a specific car for one or more events, but dispensations are limited to one year maximum. The TC's decision will be final.

2. DEFINITIONS.

2.1 Group N Engine

An engine produced and sold in quantities exceeding 2500 in one year and complying to FIA App J Art. 254 i.e. in the as manufactured condition, with no modifications to its internal components. To be accepted as such, an engine must be certified, and sealed by an MSA appointed inspector before installation. It may be required to strip an engine for inspection.

2.2 Modified Engine

All other non-certified engines used in the *SA Rally-Raid Championship*.

2.3 A re-engined Vehicle

A production vehicle fitted with an engine not manufactured by the manufacturer of the body and chassis of the vehicle.

2.4 Intake Manifold

i) Petrol engines: Part collecting the combustion air, and extending from the mounting face on the inlet ports of the cylinder head to the throttle valve *plate*.

ii) Diesel engines: Part collecting the combustion air, and extending from the mounting face on the inlet ports of the cylinder head to the first junction with the air ducting from the air filter *for NA engines or the first junction with the air ducting from the charge air cooler for turbo engines*.

2.5 McPherson Suspension

Any suspension system in which a telescopic strut, not necessarily providing the springing and/or damping action, but incorporating the stub axle, is anchored on the body or chassis through a single attachment point at its top end, and is pivoted at its bottom end either on a transversal wishbone locating it transversally and longitudinally, or on a single transversal link and located longitudinally by an anti-roll bar, trailing arm or compression rod.

2.6 Suspension Travel Measurement

The method for measuring the suspension travel is the following:

2.6.1 The vehicle must be level on stands on a hard, flat, level, surface with the springs and dampers removed.

2.6.2 For independent suspension:

- Where the bump and droop stops are mounted separately from the dampers, the external energy absorbers i.e. rubber stops, springs, hydraulic stops, droop straps, etc. must be removed. Solid dummy spacers may be mounted to take the place of solid parts in the energy absorbers to simulate the correct travel.

- Where telescopic dampers fulfil the task of bump and droop stops the dampers must remain fitted, but energy absorbers i.e. rubber stops, springs, hydraulic stops, etc. must be removed, including internal ones.

Solid dummy spacers may be mounted to take the place of solid parts in the energy absorbers to simulate the correct travel.

- The measured wheel travel is the vertical displacement of the wheel centre when displaced between the upper bump stop and lower droop stop.

2.6.3 For suspension with rigid axles:

- The vehicle must be level on stands on a hard, flat, level, surface with the springs and dampers removed.

- Where the bump and droop stops are mounted separately from the dampers, all energy absorbers i.e. rubber stops, springs, hydraulic stops, etc. must be removed. Where droop straps are used as standard, the standard droop straps must be retained. Solid dummy spacers may be mounted to take the place of solid parts in the energy absorbers, including droop stops, to simulate the correct travel.

- Where telescopic dampers fulfil the task of bump and droop stops the dampers must remain fitted, but energy absorbers i.e. rubber stops, springs, hydraulic stops, etc. must be removed, including internal ones. Solid dummy spacers may be mounted to take the place of solid parts in the energy absorbers to simulate the correct travel.

- Where leaf springs are mounted to locate the axle as well as provide the spring medium, the leaf springs must remain fitted. The damper or droop strap without energy devices also remain fitted. The distance with axle hanging at full droop to solid portion of bump stop must be measured on left and right sides.

- The measured wheel travel is the simultaneous vertical measurement of the left and right wheel centres between the upper bump stops and lower droop stops. Both the left and right hand measurements must be within specification.

2.7 Bump and droop Stops

Bump and droop stops are defined as solid, elastic and/or hydraulic buffers, stopping/damping the suspension at the end of its travel upward and downward. Bump and droop stops do not form an active part of the suspension except at the end of the travel upwards and downwards.

2.8 Anti-Tramp Rods

Anti-tramp rods on *rigid axles* shall comprise a single central longitudinal rod or one longitudinal rod per side, which prevents leaf spring twist under acceleration and braking. The rods shall be one piece, shall offer no lateral support to the axle, and shall make an angle of less than 10° with the longitudinal axis of the vehicle.

2.9 Technical Passport

A document issued by the *SA Rally-Raid Exco* which must accompany each competing vehicle to each event it competes in. This document identifies the vehicle and contains all the technical details including deviations and upgrades for the specific car. The onus is on the competitor to update the technical details in the document. The document may be updated on-line or at scrutineering and stamped by the Technical Delegate. Failure to produce this document on request may result in a fine of R 500.00. The reference to the date of the passport must be understood as the date on which the *SA Rally-Raid* technical passport was first issued. The Technical Passport contains the history of the vehicle, and remains with the vehicle when sold.

2.10 Reserved

2.11 Fuel for all classes, FIA included

As per GCR 240. Only 93 or 95 octane commercially available pump petrol may be used.

Only commercially available pump diesel may be used.

No additives allowed *in the fuel*.

The TC's may collect fuel samples for analysis if required.

3. PERFORMANCE CONTROLS.

3.1 Minimum Weights

All cars are subject to the following scale of minimum weights in relation to cylinder capacity, unless otherwise specified in the individual class technical specifications. For forced induction engines, the nominal cylinder capacity is multiplied by 1,7 and the car must pass into the class corresponding to the fictive volume thus obtained. The car must be treated in all respects as if its cylinder capacity thus increased were its real capacity. This is particularly the case for assigning the car to its cylinder capacity class.

Note: Production vehicles in Class S will comply to the 2014 regulation, which is 60 kg higher than the table below. Refer Art 13.4.1.2

The FIA class refers to 2022 Cross-Country Rally Sporting Regulations art 8.4.6 Weight.

Cylinder Capacity in cc.	Weight in kg (4x4)	Weight in kg (4x2)
Up to 1600	1090	800
Over 1600 and up to 2000	1290	920
Over 2000 and up to 2250	1440	950
Over 2250 and up to 2500	1540	980
Over 2500 and up to 2750	1577.5	1010
Over 2750 and up to 3000	1615	1040
Over 3000 and up to 3250	1652.5	1070
Over 3250 and up to 3500	1690	1100
Over 3500 and up to 3750	1727.5	1130
Over 3750 and up to 4000	1765 (1825 class S)	1160
Over 4000 and up to 4250	1802.5	1190
Over 4250 and up to 4500	1840	1220
Over 4500 and up to 4750	1877.5	1250
Over 4750 and up to 5000	1915	1280
Over 5000 and up to 5250	1952.5	1310
Over 5250	1990	1340

This is the weight of the car without fuel, with spare wheel/s as fitted at all times during the event. All Production Vehicles shall carry and be weighed with two spare wheels of the size fitted on the car. All Special Vehicles shall be weighed with one spare wheel of the size/s fitted on the car.

The engine cooling fluid and lubricants, as well as the brake fluid must be at normal levels.

The other tanks for consumable liquids must be drained and the following elements must be removed from the car:

- Occupants, their equipment and luggage.
- Tools, portable jack and spare parts.
- Survival equipment.
- Provisions.

For weighing purposes, obvious lost components may be added at the discretion of the Clerk of the Course, and heavy mud and sand may be required to be cleaned before weighing.

The weight of the car may be completed by adding one or several ballast weights, provided they are strong and unitary blocks, fixed by means of tools, capable of having seals affixed and of being placed on the floor of the cockpit, visible and sealed by the Technical Delegate.

3.2 Power output restrictions

3.2.1 The controllers reserve the right to restrict the power output of any competing vehicle.

3.2.2 All competing vehicles in the Championship, may be fitted with induction air restrictors. The preferred method of engine power reduction will be the use of an induction air restrictor of a size and shape specified by the controllers, suitable to reduce the power output of any competitor's engine in the interest of performance equalization. The figures listed below in clauses 3.2.8 i) *and* ii) are the maximum diameter (mm) that restrictors may be for each application listed and must be in compliance when measured at ambient temperature. The axial length of the restrictor diameter must be 3mm, minimum.

3.2.3 On all engines, all induction air must pass through the restrictor at all times.

3.2.4 In the case of forced induction diesel engines, the exit of the inlet air restrictor (3mm parallel portion) must be within 50mm of the extremities of the turbo compressor impeller blades on the inlet side. The internal volume of the induction pipe between the outlet of the restrictor (turbo side of the 3mm parallel portion) and the throttle body valve may not exceed 10 litres.

3.2.5 The controllers reserve the right to conduct a "stall test" on all relevant competing vehicles at any time during the race meeting. The "stall test" involves inserting a machined plug of the specified diameter. (Refer 3.2.8 i) *and* ii) into the restrictor, at which point the engine must stall (cease to run). Any engine, subjected to the test that continues to run, will be deemed to have additional air being supplied, and therefore has a system that is non-compliant.

3.2.6 Restrictors:

ENGINE TYPE	DESCRIPTION	RESTRICTOR SIZE (ID mm)
i) FIA classes	Refer FIA Cross-Country Rally Sporting Regulations table 8.4.5	
ii) Petrol engines Gp N NA:	- Gp N engines, all except V8 rocker.	37
	- Gp N V8 rocker arm engines over 5400 cc, 4x2, class A	39
	- Ford, Nissan & Toyota, 4000cc max, class S, minimum weight exceeding 1900 kg.	39
	- Ford, Nissan & Toyota, 4000cc max, class S, min weight exceeding 1825 kg.	37
	Ford Gen 2 engine 5000cc max, class T, min weight exceeding 1825 kg. Class T Nissan VK50 engine	38
- Class P, engines Gp N, 4300 cc max.	No restrictor	

3.2.7 Provision for the sealing of the engine and driveline components must be provided in the case where the TC's require sealing. The following components may require sealing and should be pre-drilled with 2mm holes through bolt heads and flanges to the satisfaction of the TC's:

- engine cam covers.

- engine oil sump.
- engine front covers.
- engine inlet manifolds and throttle bodies.
- turbochargers and intercoolers.
- gearboxes and differentials.
- ECU's.

Seals broken without a TC's approval will result in exclusion and loss of championship points dated back to when the seal was fitted.

Should a team want to open an engine or other sealed component for inspection or repair, the TC should be contacted, and arrangements made for the TC to be present when the seals are removed. The TC may then check compliance to regulations if so required. The TC will reseal the component after repair. The onus is on the Team to ensure the engine and other components are to specification, sealed and recorded. Refer GCR 93 iii).

The correct engine number must always be recorded in the Technical Passport.

3.3 FIA Classes

All performance controls will be based on the FIA regulations.

3.4 SA Rally-Raid Turbo Strategy

3.4.1 The purpose of the strategy is to balance the performance of turbo petrol engines to the FIA specified 5 litre NA (Normally Aspirated) Ford engine power curve. This will only be applicable in the *SA Rally-Raid Championship* for cars in the FIA T1 class with supercharged (turbocharged) petrol engines. Competitors wishing to compete in full FIA specification may do so.

i. The strategy will be based on the FIA regulations in App J Art 285, but simplified. The *SA Rally-Raid Championship* required ECU, Data logger, sensors and harness may differ from FIA regulation to limit costs. Should teams compete in FIA events, only the additional ECU's, loggers and harnesses will be required. *SA Rally-Raid Championship* requirements in art 3.4.2

ii. Method to balance performance NA versus Turbo:

The turbo boost curve will be generated on a specified dyno to produce a power curve not exceeding the FIA specified NA power curve. See Drawing 1. The boost curve will be adapted at all competing altitudes whilst driving by using the FIA specified control strategy as a guideline. T1 Petrol supercharged engines - Clarification of the current technical regulations 01/10/2020.

The boost control strategy will be based on the following parameters:

- MAP = Manifold Absolute Pressure as measured in the inlet manifold (mB).
- BAP = Barometric Absolute Pressure atmospheric air pressure (mB).
- rpm = engine speed (rpm)
- Pref = BAP at sea level (1010 mBar).
- Pambient = BAP at the car racing (mB).
- PRPboost/Pref = MAP/Pref gives the boost ratio through the full range of engine speeds to match the NA base power curve.
- MAPboost curve = (PRPboost/Pref @ rpm).Pambient
= MAP values at the full range of engine speeds to give the power as per the base power curve, drawing 1. Not to be exceeded.

3.4.2 *SA Rally-Raid Championship* Data Logging Requirements:

i. Motec ECU model M142 including data logger with separate password protected memory accessible to *SA Rally-Raid* Technical Delegates only.

ii. The required inputs for data logging (refer also App J art 285)

- a. *Inlet* Manifold Absolute Pressure. 20Hz
- b. Barometric Absolute Pressure. 2Hz
- c. GPS altitude. 1Hz
- d. GPS speed. 1Hz
- e. Engine rpm. 20Hz
- f. Pedal position. 5Hz
- g. Ignition timing. 20Hz
- h. Lambda. 5Hz
- i. VVT. 10Hz
- j. *Inlet* Manifold air temperature. 1Hz

- k. Air temperature at air cleaner inlet. 1Hz
- iii. *Sensors to be installed in the positions as required by the FIA, and approved by the TC.*
- iv. Harnesses must be installed clearly visible and accessible from sensors to ECU and data logger for inspection.
- v. The above data must be logged when the car is running from start control to end control, and must be made available to the *SA Rally-Raid* Technical Delegates whenever requested, including any additional ECU data.
- vi. Overboost will be recorded when:
 - throttle is $\geq 10\%$ open;
 - AND
 - r.p.m. ≥ 2000
 - AND
 - road speed ≥ 10 km/h constant or increasing;
 - boost is recorded \geq boost limit plus 15 mbar for more than 0,5 seconds.
 Lambda minimum lower (no richer than) than specified.
- vii. Penalties: 20 seconds per overboost as in vi. or lambda exceeded for more than 1 second. The *Clerk of the Course* may increase the penalty for repeated offences.
- viii. The balance of performance may be adjusted by the Technical Delegates if required. Other competitors wishing to compete with turbo engines in the FIA class will have to construct a power curve on a specified dyno.

DRAWING 1: BASE FIA POWER CURVE

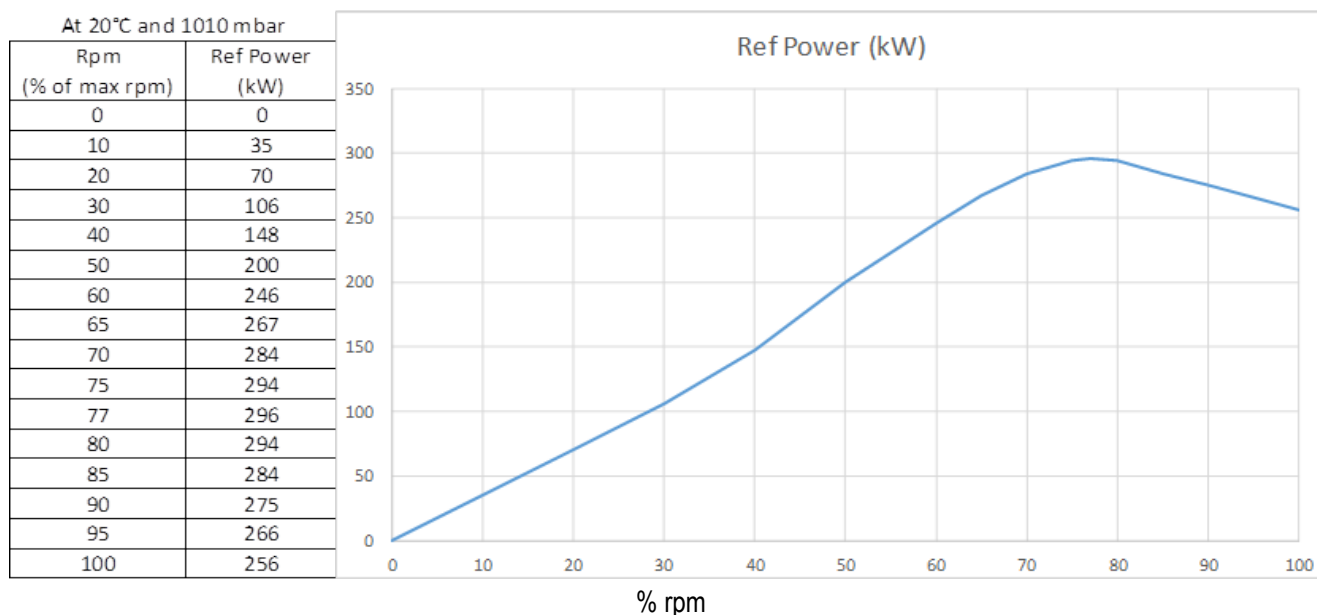

3.4.3 SA RALLY-RAID CHAMPIONSHIP T1 SUPERCHARGED PETROL ENGINE LIST

The procedure for adding an engine to this list, and the related forms, are available on the FIA website dedicated to cross-country regulations under "Related Documents". *SA Rally-Raid* competitors request listing in writing from the Commission.

3.4.3.1 NEIL WOOLRIDGE MOTORSPORT.

CAR: Ford Ranger T1 with FORD 3.5 GTDI V6 ECOBOOST petrol engine

FIA updated boost curve

Date	T/C petrol engine number	Tuner	Base engine	Fuel
21/04/2022	2021-004	NWM	FORD 3.5L GTDI V6 ECOBOOST	Any fuel compliant with Art. 252-9.1

Engine rpm	2500	2750	3000	3250	3500	3750	4000	4250	4500	4750	5000	5250	5500
Pboost ratio Max at 1010 mbar	1,63	1,65	1,67	1,69	1,70	1,71	1,72	1,75	1,75	1,75	1,72	1,64	1,55
Engine rpm	5750	6000	6250	6500									
Pboost ratio Max at 1010 mbar	1,49	1,43	1,39	1,35									

Declared minimum Lambda	0,89
-------------------------	------

- i. The NWM Ford will use the Tial Sport QRJ 38 mm mechanical blow off valve as per FIA.

3.4.3.2 HALLSPEED TOYOTA GAZOO.

CAR: Toyota Hilux T1 and T1+ with TOYOTA V35A-FTS 3,5 turbo petrol engine

Date	T/C petrol engine number	Tuner	Base engine
17/11/2021	tba	HALLSPEED	TOYOTA V35A-FTS 3,5 TURBO PETROL

Engine rpm	2500	2750	3000	3250	3500	3750	4000	4250	4500	4750	5000	5250	5500	5750	6000	6250	6500
Pboost ratio Max (-) at 1010 mbar	1,58	1,69	1,79	1,81	1,83	1,91	1,98	2,01	2,04	2,03	2,03	1,90	1,76	1,68	1,59	1,54	1,46

Declared minimum Lambda	0,90
-------------------------	------

4. EXHAUST SYSTEMS

All vehicles must be fitted with steel exhaust systems that exit to the back and/or face upwards from the horizontal.

Vehicles with side exit exhausts will be acceptable providing the exhaust is made to exit upwards. Downward facing exhausts are not acceptable. To prevent fires starting as a result of a vehicle coming to rest in dry grass or undergrowth, exhaust systems that run under vehicles must be protected by a heat shield or be wrapped with insulating material. Exhausts will be inspected by the Technical Delegate for fire compliance, and if necessary, repairs will have to be made for approval from the Technical Delegate before starting the race. Competitors are to ensure that the engine management systems are set to cut fuel on overrun, including the sequential gear flatshift, to eliminate exhaust flame-spitting under all racing conditions. A race vehicle seen with flames out the exhaust at any time may be suitably penalised up to immediate exclusion. Refer SSR 318 C and GCR 157

5. WINDOWS, SAFETY NETS, MIRRORS, CUTTERS

- 5.1 Side doors or side openings without windows for the crew must have the window area covered by adequately secured safety nets. It is mandatory that all safety nets are attached to the roll cage of the competition vehicle with sturdy quick release buckles to allow quick emergency exits. The upper side of the net must be permanently fixed to the structure, and not removable without tools. The safety net must cover the side area between the steering wheel and the back of the seat, and from the roof to below the elbow.
- 5.2 The safety net must be made of sturdy webbing straps with minimum strap width 15mm and maximum strap width 25mm professionally sewn together in square blocks. The square block aperture must be more than 40mm per side and less than 80mm per side to allow side visibility to the crew but also protect the hands and arms flying about in an accident. Shade net, fishnet, etc., not allowed.
- 5.3 Polycarbonate Side Windows: windows must be to specification Lexan F2000 Sheet or equivalent, minimum thickness 3mm. It must be possible to remove the windows from inside the car without tools very quickly.
The size of the opening in a side window may not exceed 175 x 175 mm.
- 5.4 All vehicles must carry an AA Life Hammer and/or blade knife which will be attached by means of Velcro on an orange background in a position accessible to the driver and navigator (normally seated with safety harness fastened), and to officials.
- 5.5 Rear View Mirrors: All competing vehicles must be fitted with either, a rear view mirror (central and within the passenger compartment) or two rear view mirrors (one each side of the vehicle on the outside of the passenger compartment) or both. The minimum size of the single inside mirror is 144cm squared, and of the two outside mirrors are 60cm squared each. All mirrors must be able to see vehicles following, be in good condition and, in the case of the outside mirrors, have good protection.

6. FIRE EXTINGUISHERS.

All vehicles must be fitted with a minimum of two handheld fire extinguishers.

One handheld extinguisher is to be fitted in the crew compartment in a place accessible to the driver and/or navigator.

The second handheld extinguisher is to be mounted externally on the vehicle in an accessible position, as best as possible protected against tree branches, flying stones and direct sunlight, and as far away as possible from the fuel tanks, oil tanks and engine of the vehicle.

The handheld extinguishers must be secured by a minimum of 2 screw-locked metallic straps and the securing system must be able to withstand a deceleration of 25 g. Only quick-release metal fastenings with metal straps will be accepted. The handheld fire extinguishers shall comply with SABS 1910 for the extinguisher cylinder with a minimum capacity of 2,5kg DCP (dry chemical powder) extinguishant. The extinguishant shall be MAP (mono-ammonia-phosphate), containing a minimum of 70% MAP in the DCP (Note the 70% is higher than the industry standard 40%). The DCP shall comply with SANS 1522.

Alternatively the 2.4 litre AFFF foam types as listed by FIA may also be used. Note, two handhelds are required as stated above, not one as per FIA. One dry powder and one AFFF foam handheld extinguisher may be used as a pair.

In this case the AFFF should be fitted in the crew compartment, as it is easier to breathe when used in a confined space the following information must be visible on each handheld extinguisher:

- type of extinguishant
- weight or volume of the extinguishant
- date the extinguisher must be checked, which must be no more than one year after either the date of filling or the date of the last check, or corresponding expiry date.
- each handheld extinguisher must be equipped with a pressure gauge to check the pressure of the contents.

Mounted piped systems to FIA Standard 8865-2015 (Technical List n°52) are recommended, but will be regarded as additional to that specified above.

- NOTES:**
1. Handheld fire extinguishers in vehicles should ideally be taken out every six months, as the extinguishant can compact with road vibration. Turn upside down to loosen the powder and replace.
 2. Anti-freeze in the cooling system should be no more than 50%. The rest should be water to minimise fire risk of ethylene glycol.

7. FUEL TANKS

- 7.1 Fuel must be carried in metal/moulded plastic tanks of acceptable quality and safety standards or FIA approved fuel cells which are within their expiry period. The original expiry period may be extended after inspection by the Technical Delegate upon request of the competitor and recorded in the Technical Passport. Metal/moulded plastic tanks must be Commission Approved and recorded in the Technical Passport with a serial number. The minimum wall thickness of moulded plastic tanks must be 6mm. The material should be resistant to degradation by all automotive fuels, i.e. petrol, diesel, alcohols and additives as well as to flame propagation.
The material should have a measure of U-V resistance, not be susceptible to static charge loading, and have sufficient toughness to withstand cross-country racing damage.
The use of safety foam in tanks is recommended.
- 7.2 Tanks must be efficiently protected and very firmly attached to the body shell or the chassis of the car. Ideally all non-metal tanks should be carried in metal holders, at least the size and shape of the bottom half of the tank, to carry the full fuel weight and to protect the tank against external damage.
All tanks must be secured to the frame or chassis by at least two straps which are at least 50mm wide and minimum 1.5mm thick for steel. Straps to be separated from the tank by a non-metallic strip to prevent abrasion. In all cases, the tank including the filling pipes, must be totally insulated by means of flameproof and liquid-tight bulkheads or casings, preventing the infiltration of fuel into the cockpit or contact with the exhaust pipes. No part of a fuel tank system may be fitted or protrude outside of the chassis/safety cage of the vehicle.
- 7.3 All vehicles must have fuel lines which are secured and in good condition. The breather pipe must be fitted with a gravity activated roll-over valve *and routed up, across, and down below the fuel tank bottom*, so that no matter which way a vehicle is rolled, a portion of the breather pipe will be higher than the tank, thus preventing fuel spillage.
- 7.4 No fuel will be permitted to be carried in loose containers.

8. BATTERIES, LIGHTING, ELECTRICAL.

- 8.1 The battery/ies must be securely fitted. No more than two batteries allowed. *The batteries must be fitted inside the safety cage/chassis. Batteries* must be covered against damage and short circuits.
Acid type batteries fitted in the passenger cabin must be contained in a leak proof box.
- 8.2 All vehicles must have *two* battery isolator switches fitted in obvious positions, clearly marked *inside and outside the car where it is* accessible to the driver and navigator and external rescue personnel. This switch must be wired so that the engine *and all electrical ancillaries'* cuts out when it is operated.
- 8.3 All vehicles must have ignition coils mounted away from fuel lines and fuel pumps.
- 8.4 White lights: All vehicles must have at least one white light of 55 watt (550 Lumen) intensity minimum, visible from the front of the vehicle, fitted and operational throughout the event, to enable the vehicle to be visible to other competitors being approached. Refer SSR 313. This white light may be the production vehicle's own head or driving light/s and must be protected by a cage to prevent it from being displaced.
Special Vehicles must have these lights mounted as high as possible, preferably just under roof height, and preferably two lights, one at either side just inside the A-pillar.
- 8.5 Yellow lights: For safety reasons yellow lights are required to be fitted at the rear of all vehicles and be operational for the duration of the event. This provides more visibility in dust during close racing. The lights must be activated by the main battery isolator switch only, and have no other auxiliary isolator switch. The lights must be fitted within 500mm of the vertical centreline of the vehicle and within 300mm of the highest point of the vehicle. *Refer SSR 313.*
The lights must be placed so that it can be seen from ground level 15 metres from the rear of the vehicle.
The following lights define the minimum specification for rear mounted yellow lights in *SA Rally-Raid Championship*

- 8.5.1 VISIONX Solo Pod LED light series:
 i) Prime model, item no XIL-SP120, beam 20° or
 ii) Solstice model, item no XIL-S1130, beam 30°
 Available from **TORRE PARTS** (formerly Control Instruments) at <http://www.torreparts.com/visionx/>
- 8.5.2 Premium Motorbike Spot 10W Available from **Extreme Lights** at
<https://www.extremelights.co.za/collections/motorbike-lights>
- 8.5.3 Lamin-X 20x10cm Mini sheets yellow, to cover the light lens for the yellow colour.
 Available from: **Autostyle** at
<https://www.autostyle.co.za/lamin-x-20x10cm-mini-sheets-yellow.html>

9. SAFETY BELTS

9.1 Belts:

The wearing of a 5 or 6-point harness is compulsory.

Anchorage points on the shell or the chassis or the cabin or the safety cage: 2 for the lap strap, 2 for the shoulder straps, 1 or 2 for the pelvic strap(s).

These belts must comply with MSA GCR 239 as a minimum requirement.

The ASN's may homologate mounting points on the safety cage when this cage is being homologated, on condition they are tested.

9.2 Installation:

It is prohibited for the seat belts to be anchored to the seats or their supports.

The anchorage points of the series vehicle (Groups T2 and T4) must be used.

If the installation on the series anchorage points is impossible, new anchorage points must be installed on the shell or the chassis or the cabin, a separate one for each strap the furthest rearward as possible for the shoulder straps.

Care must be taken that the straps cannot be damaged through chafing against sharp edges.

The recommended geometrical locations of the anchorage points are shown in Drawing 253-61.

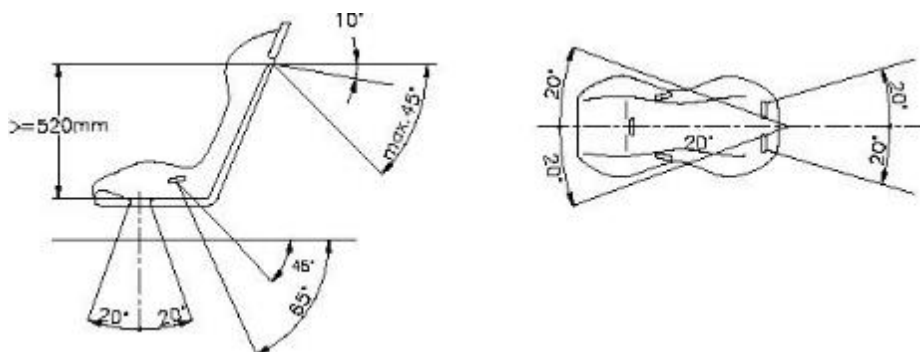

In the downwards direction, the shoulder straps must be directed towards the rear, and must be installed in such a way that they do not make an angle of more than 45° to the horizontal from the upper rim of the backrest (20° from the driver's shoulders in T4), although it is recommended that this angle should not exceed 10°.

The maximum angles in relation to the centre-line of the seat are 20° divergent or convergent (measurement in horizontal projection).

If possible, the anchorage point originally mounted by the car manufacturer on the C-pillar must be used.

Anchorage points creating a higher angle to the horizontal must not be used.

If mounting on the series anchorages is impossible, the shoulder straps may be fixed or leaning on a rear transverse tube fixed to the cage or to the top anchorage points of the front belts.

The shoulder straps may also be fixed to the safety cage or to a reinforcement bar by means of a loop, and may also be fixed to the top anchorage points of the rear belts, or be fixed or leaning on a transverse reinforcement welded between the backstays of the cage (Refer Drawing 253-66).

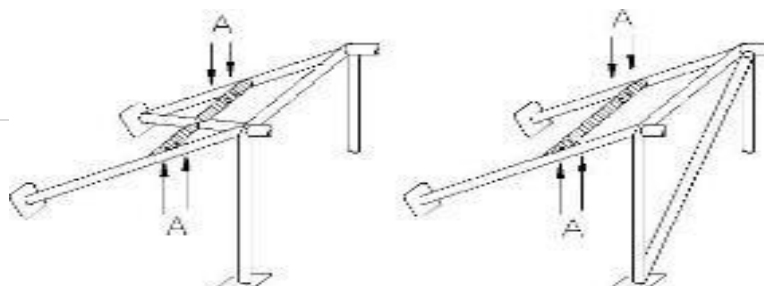

In this case, the use of a transverse reinforcement is subject to the following conditions:

- The transverse reinforcement must be a tube measuring at least 38mm x 2.5mm or 40mm x 2mm, made from cold drawn seamless carbon steel, with a minimum tensile strength of 350 N/mm².
- The height of this reinforcement must be such that the shoulder straps, towards the rear, are directed downwards with an angle of between 10° and 45° (20° in T4) to the horizontal from the rim of the backrest (or the driver's shoulders in T4), an angle of 10° being recommended.
- The lap and crotch straps must not pass over the sides of the seat but through the seat, in order to wrap and hold the pelvic region over the greatest possible surface. The lap straps must fit tightly in the bend between the pelvic crest and the upper thigh. Under no conditions must they be worn over the region of the abdomen.
- The straps may be attached by looping or by screws, but in the latter case an insert must be welded for each mounting point (Refer Drawing 253-67 for the dimensions).

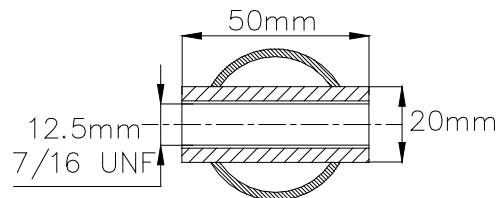

253-67

These inserts must be positioned in the reinforcement tube and the straps must be attached to them using bolts of M12 8.8 or 7/16 UNF specification.

Each anchorage point must be able to withstand a load of 1470 daN, or 720 daN for the crotch straps.

In the case of one anchorage point for two straps (prohibited for shoulder straps), the load considered must be equal to the sum of the required loads.

For each new anchorage point created, a steel reinforcement plate with a surface area of at least 40 cm² and a thickness of at least 3mm must be used.

9.3 Principles of mounting to the chassis/monocoque:

General mounting system: Refer Drawing 253-62

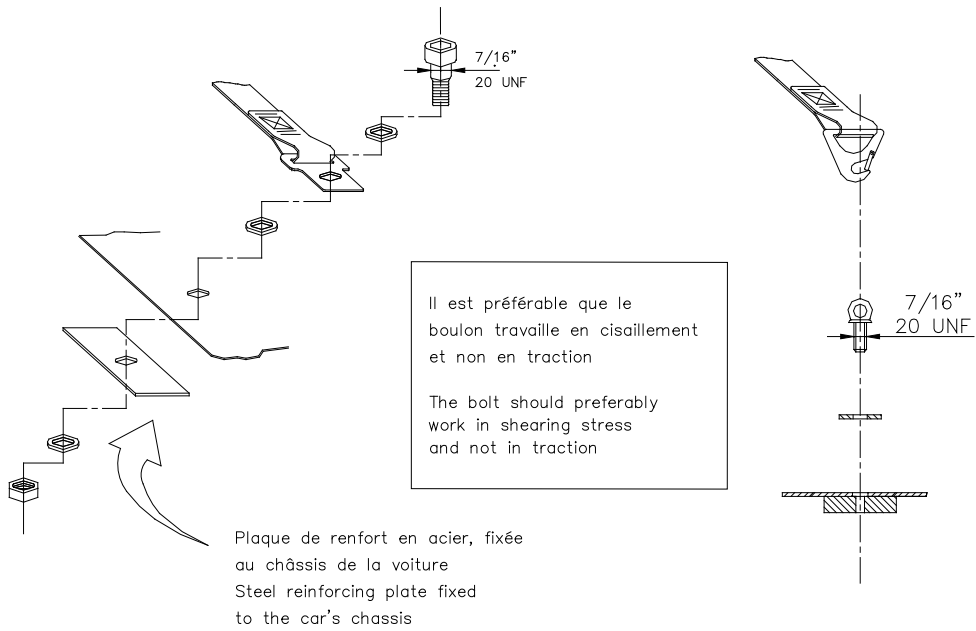

253-62

Shoulder strap mounting: Refer Drawing 253-63

plaque fixée au châssis de la voiture et renforcée
de l'autre côté par une plaque de renfort

plate fixed to the chassis and strengthened
by a reinforced plate on the other side

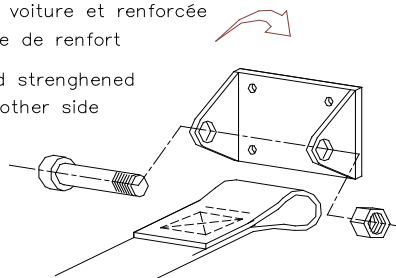

253-63

Crotch strap mounting: Refer Drawing 253-64.

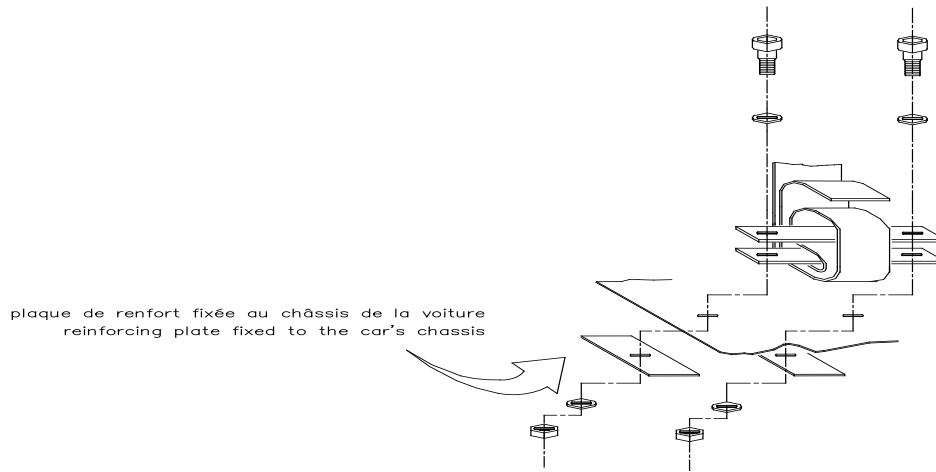

253-64

9.4 Use:

A safety harness must be used in its homologation configuration without any modifications or removal of parts, and in conformity with the manufacturer's instructions.

The effectiveness and longevity of safety belts are directly related to the manner in which they are installed, used and maintained.

The belts must be replaced after every severe collision, and whenever the webbing is cut, frayed or weakened due to the actions of chemicals or sunlight.

They must also be replaced if metal parts or buckles are bent, deformed or rusted. Any harness which does not function perfectly must be replaced.

9.5 Note: It is not allowed to mix parts of seat belts. Only complete sets, of proprietary manufacture, may be used.

10. SEATS AND SEAT MOUNTINGS (APP J. ART 253.16).

If the original seat attachments or supports are changed, the new parts must either be approved for that application by the seat manufacturer or must comply with the specifications mentioned below:

10.1 Anchorage points for fixing the seat supports:

The seat supports must be fixed either:

- on the anchorage points for fixing seats used on the original car
- on the anchorage points for fixing seats homologated by the manufacturer as an Option Variant (in which case the original anchorage points may be removed)
- on anchorage points for fixing seats in conformity with Drawing 253-65B.

The seat supports must be fixed to the anchorage points for fixing seats via at least 4 mounting points per seat, using bolts measuring at least 8mm in diameter

**INTERDICTION DE SOUDER LES PLATINES SUR LES CONTRE PLAQUES
END PLATES MUST NOT BE WELDED ON THE COUNTERPLATES**

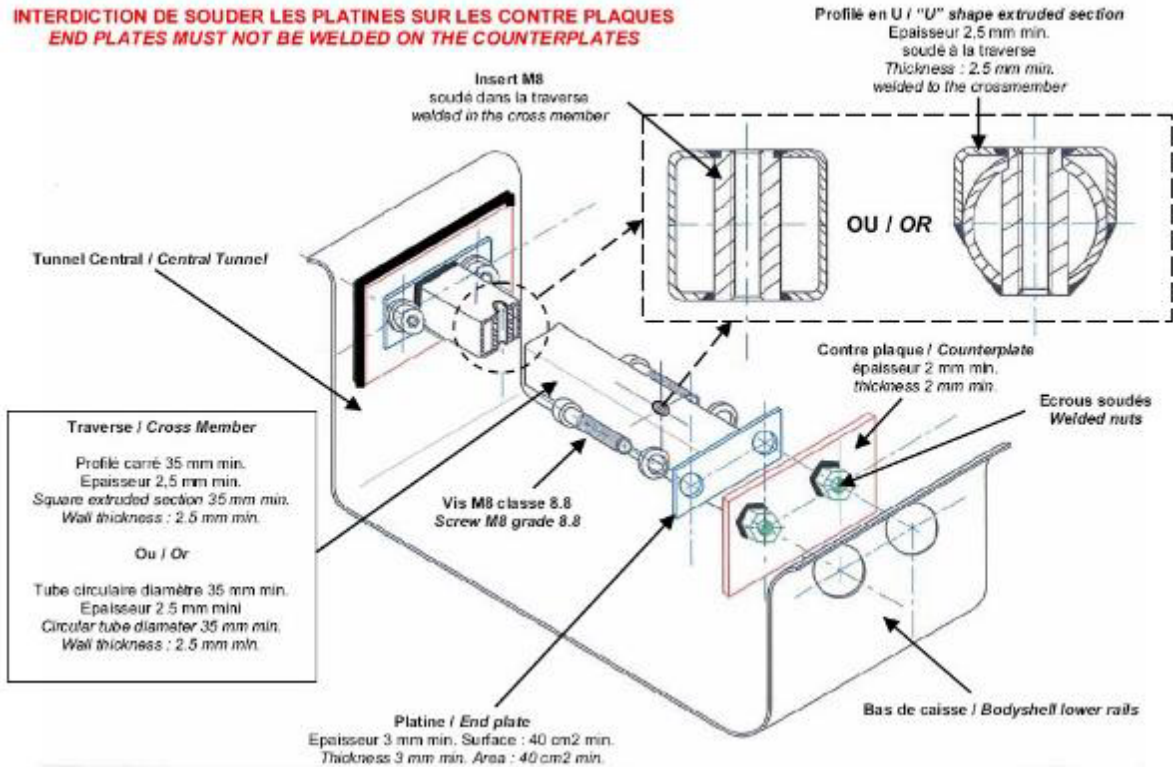

253-65B

FITTING INSTRUCTIONS:

- 1 Drill holes (larger than nut outer diameter) in the body shell lower rail and in central tunnel wall.
- 2 Weld the nuts on the counter plates, then weld these on the body shell lower rail on the central tunnel wall.
- 3 Weld the 2 threaded inserts in the cross member, then weld the endplates at each end of the cross member.
- 4 Fix the assembly through 4 x M8 screws of 8.8 grade which will be screwed in the welded nuts.

10.2 Fixing of the seat supports directly onto the shell/chassis:

Supports must be attached to the shell/chassis via at least 4 mounting points per seat using bolts with a minimum diameter of 8 mm and counter plates, according to the Drawing 253-65.

The minimum area of contact between support, shell/chassis and counter plate is 40 cm² for each mounting point.

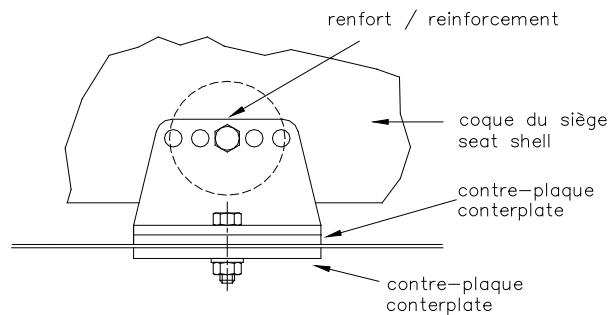

253-65

10.3 If quick release systems are used, they must be capable of withstanding vertical and horizontal forces of 18000 N, applied non-simultaneously.

If rails for adjusting the seat are used, they must be those originally supplied with the homologated car or with the seat.

10.4 The seat must be attached to the supports via 4 mounting points, 2 at the front and 2 at the rear of the seat, using bolts with a minimum diameter of 8 mm and reinforcements integrated into the seat.

Each mounting point must be capable of withstanding a force of 15000 N applied in any direction.

10.5 The minimum thickness of the supports and counter plates is 3mm for steel and 5mm for light alloy materials.

The minimum longitudinal dimension of each support is 6cm.

- 10.6** If there is a cushion between the homologated seat and the occupant, the maximum thickness of this cushion is 50mm.
 All the occupants' seats must be homologated by the FIA (8855/1999 standard), and not modified. The limit for use is 5 years from the date of manufacture indicated on the mandatory label.
 An extension of 2 further years may be authorised by the manufacturer and must be indicated by an additional label.

11. CHASSIS AND SAFETY CAGE.

(Applicable from 01/01/2015)

- 11.1** The chassis must either:
- derive from a chassis (or monocoque body) of the vehicle specified in the technical passport.
 - or be a tubular frame chassis in ferrous materials only.
- The wall thickness of the tubes forming the structural part of the chassis must not be less than 1.5mm.
 All tubes of the safety cage defined in Drawings 253-1, 253-2, 253-3 must have a minimum section of 50x2mm (2.0"x0.083") or 45x2.5 mm (1.75"x0.095").
 Padding in the form of 60-240 kg/m³ material, with a minimum thickness of 40 mm, must be fitted on the steering wheel over a minimum surface of 20 000 mm² (200 cm²) to protect the driver's face.
 The car must have a structure immediately behind the crew seats that are wider than their shoulders and extends above them when they are seated normally in the car with their seat belts fastened.

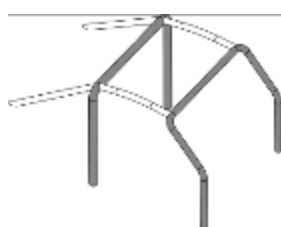

253-1

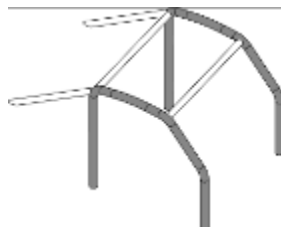

253-2

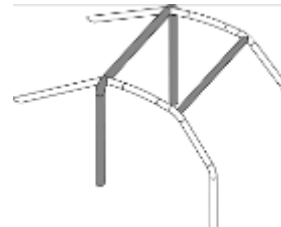

253-3

11.2 General:

- 11.2.1** The fitting of a safety cage is compulsory and must comply with the requirements. The safety cage must be either homologated by the FIA, or accepted by MSA, based on the fulfilment of the requirements as set out in Art 11.4. (Also Refer Art 1.4).
 Photographs of the safety cage will be placed in the Technical Passport of the vehicle. No modifications to the safety cage as entered in the passport will be allowed.
 In the case where a safety cage has been damaged, it has to be presented to the Technical Delegate for inspection, and a proposed repair procedure presented for approval in consultation with the original manufacturer.
 The repair will be recorded in the passport.
- 11.2.2** The safety cage may be either:
- a. Fabricated in compliance with the requirements of the following articles;
 - b. Homologated or Certified by MSA according to the homologation regulations for safety cages;
 An authentic copy of the homologation document or certificate, approved by MSA and signed by qualified technicians representing the manufacturer, must be presented to the event's scrutineers. Any new cage which is homologated by MSA and is on sale must be identified by means of an identification plate affixed to it by the manufacturer. This identification plate must be neither copied nor moved (i.e. embedded, engraved or self-destroying sticker). The identification plate must bear the name of the manufacturer, the homologation or certification number of the MSA homologation form or certificate and the individual series number of the manufacturer. A certificate bearing the same numbers must be carried on board and be presented to the event's scrutineers.
 - c. Homologated by the FIA according to the homologation regulations for safety cages;
 The manufacturer's identification and a series number must be clearly visible on all cages homologated and sold after 01.01.1997.
 The homologation form of the cage must specify how and where this information is indicated, and the purchasers must receive a numbered certificate corresponding to this. Any modification to a homologated or certified safety cage is forbidden. To be considered as a modification, any process made to the cage by

machining, welding, that involves a permanent modification of the material or the safety cage. All repairs to a homologated or certified safety cage, damaged after an accident must be carried out by the manufacturer of the Safety Cage or with his approval.

11.2.3 Tubes must not carry fluids or any other item.

11.2.4 The safety cage must not unduly impede the entry or exit of the driver and co-driver.

The cars must have lateral openings in the safety cage allowing the exit of the driver and possible co- drivers. The dimensions of these openings must be such that it is possible to fit into them a rectangle at least 500 mm wide and 500 mm high, measured vertically, the corners of which may be rounded with a maximum radius of 150 mm.

The cockpit must be designed so as to allow an occupant to exit from his normal position in the vehicle within 7 seconds through the door on his side and within 9 seconds through the door on the other side.

For the purpose of the above tests, the occupant must be wearing all his normal equipment, the seat belts must be fastened, the steering wheel must be in place and in the most inconvenient position and the doors must be closed. These tests must be repeated for all the occupants of the car.

11.3 Definitions:

11.3.1 **Safety cage:**

Multi-tubular structure installed in the cockpit and fitted close to the body shell, the function of which is to reduce the deformation of the body shell (chassis) in case of an impact.

11.3.2 **Roll Bar:**

Tubular frame forming a hoop with two mounting feet.

11.3.3 **Main roll bar:** (Drawing 253-1)

Transverse and near-vertical (maximum angle +/-10° to the vertical) single piece tubular hoop located across the vehicle just behind the front seats.

The tube axis must be within one single plane.

11.3.4 **Front roll bar:** (Drawing 253-1)

Similar to main roll bar but its shape follows the windscreen pillars and top screen edge.

11.3.5 **Lateral roll bar:** (Drawing 253-2)

Near-longitudinal and near-vertical single piece tubular hoop located along the right or left side of the vehicle, the front pillar of which follows the windscreen pillar and the rear pillar of which is near-vertical and located just behind the front seats.

The rear pillar must be straight inside view.

11.3.6 **Lateral half-roll bar:** (Drawing 253-3)

Identical to the lateral roll bar but without the rear pillar.

11.3.7 **Longitudinal member:**

Near-longitudinal single piece tube joining the upper parts of the front and main roll bars.

11.3.8 **Transverse member:**

Near-transverse single piece tube joining the upper parts of the lateral half-roll bars or of the lateral roll bars.

11.3.9 **Diagonal member:**

Transverse tube between:

One of the top corners of the main roll bar, or one of the ends of the transverse member in the case of a lateral roll bar, and the lower mounting point on the opposite side of the roll bar. or

The upper end of a backstay and the lower mounting point of the other backstay.

11.3.10 **Removable members:**

Members of a safety cage which must be able to be removed.

11.3.11 **Cage reinforcement:**

Member added to the safety cage to improve its strength.

11.3.12 **Mounting foot:**

Plate welded to the end of a roll bar tube to permit its bolting to the body shell/chassis, usually onto a reinforcement plate.

This plate may be welded to the body shell/chassis in addition to the bolts.

11.3.13 **Reinforcement plate:**

Metal plate fixed to the body shell/chassis under a roll bar mounting foot to better spread the load onto the body shell/chassis.

11.3.14 **Gusset:** (Drawing 253-34)

Reinforcement for a bend or junction made from bent sheet metal with a U shape the thickness of which must not be less than 1.0mm.

The ends of this gusset (point E) must be situated at a distance from the top of the angle (point S) of between 2 to 4 times the outer diameter of the biggest of the tubes joined. A cut-out is permitted at the top of the angle but its radius (R) must be no greater than 1.5 times the outer diameter of the biggest of the tubes joined. The flat sides of the gusset may have a hole the diameter of which must not be greater than the outer diameter of the biggest of the tubes joined.

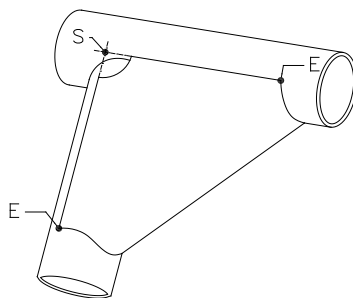

253-34

11.4 Specifications:

11.4.1 Basic structure:

The basic structure must be made according to one of the following designs:

- 1 main roll bar + 1 front roll bar + 2 longitudinal members + 2 backstays + 6 mounting feet (Drawing 253-1)
- or
- 2 lateral roll bars + 2 transverse members + 2 backstays + 6 mounting feet (Drawing 253-2) or
- 1 main roll bar + 2 lateral half-roll bars + 1 transverse member + 2 backstays + 6 mounting feet (Drawing 253-3)

The vertical part of the main roll bar must be as close as possible to the interior contour of the body shell and must have only one bend with its lower vertical part.

The front pillar of a front roll bar or of a lateral roll bar must follow the windscreen pillars as closely as possible and have only one bend with its lower vertical part.

In order to build the safety cage, the connections of the transverse members to the lateral roll bars, the connections of the longitudinal members to the front and main roll bars, as well as the connection of a semi-lateral roll bar to the main roll bar must be situated at the roof level.

In all cases, there must not be more than 4 removable connections at the roof level.

The backstays must be attached near the roofline and near the top outer bends of the main roll bar, on both sides of the car, possibly by means of removable connections.

They must form an angle of at least 30° with the vertical, must run rearwards and be straight and as close as possible to the interior side panels of the body shell.

11.4.2 Design:

Once the basic structure is defined, it must be completed with compulsory members and reinforcements (Refer Article 253-8.3.2.1), to which optional members and reinforcements may be added (Refer Article 253-8.3.2.2).

Unless explicitly permitted and unless dismountable joints are used in compliance with Article 253-8.3.2.4, all members and tubular reinforcements must be single pieces.

11.4.2.1 Compulsory members and reinforcements:

11.4.2.1.1 Diagonal member:

The cage must have one of the diagonal members defined by:

- Drawings 253-4 to 253-7 for cars homologated before 01.01.2008.
- Drawings 253-6 (Groups T1 and T3 only) and 253-7 for cars homologated as from 01.01.2008.

The orientation of the diagonal of Drawings 253-4 and 253-5 may be reversed.

In the case of Drawing 253-6, the distance between the two mountings on the body shell/chassis must not be greater than 400mm.

Members must be straight and may be removable.

The upper end of the diagonal must join the main roll bar no further than 100 mm from its junction with the backstay, or the backstay no more than 100 mm from its junction with the main roll bar (Refer Drawing 253-52 for the measurement).

The lower end of the diagonal must join the main roll bar or the backstay no further than 100 mm from the mounting foot (except for the case of Drawing 253-6).

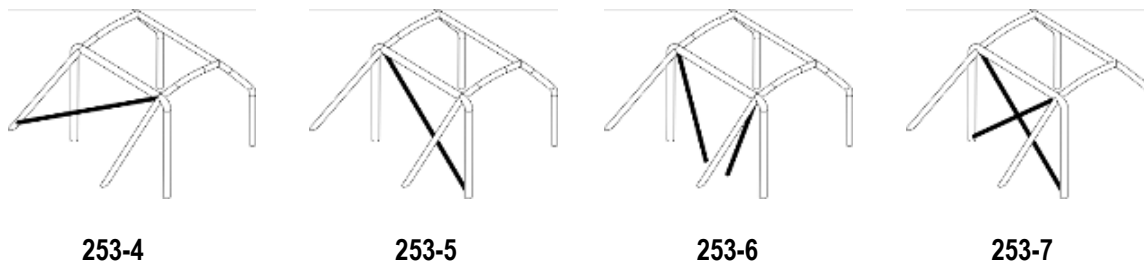

11.4.2.1.2 Door bars:

At least one longitudinal strut must be fitted on each side of the vehicle at door level (Refer Drawing 253-8). The tube(s) making up this reinforcement must be built into the Safety Cage and its (their) angle with the horizontal tube must not exceed 15° (angled downwards towards the front).

The design must be identical on both sides.

The lateral protection must be as high as possible and, if it comprises a single bar, at least 10 cm from the bottom of the seat, but in all cases its upper attachment points must not be higher than half the total height of the door measured from its base.

If these upper attachment points are located in front of or behind the door opening, this height limitation is also valid for the corresponding intersection of the strut and the door opening.

In the case of door bars in the form of an "X" (Drawing 253-9), it is recommended that the lower attachment points of the cross-struts be fixed directly onto the longitudinal member of the body shell/chassis and that at least one part of the "X" be a single-piece bar. Drawings may be combined.

The connection of the door bars to the windscreen pillar reinforcement (Drawing 253-15) is authorised.

For competitions without co-driver, members may be fitted on the driver's side only and it is not compulsory for the design to be identical on both sides.

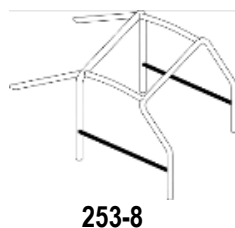

253-8

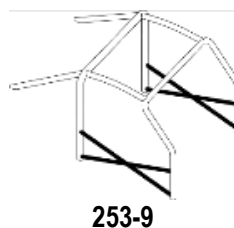

253-9

11.4.2.1.3 Transverse member: (Drawing 253-29)

The transverse member fixed to the front roll bar is compulsory, but it must not encroach upon the space reserved for the occupants.

It must be straight.

It may be placed as high as possible, but its lower edge must not be higher than the uppermost point of the dashboard.

For cars homologated as from 01.01.2007, it must not be positioned below the steering column.

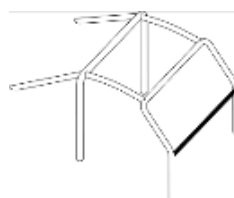

253-29

11.4.2.1.4 Roof reinforcement:

Cars homologated as from 01.01.2005 only:

The upper part of the safety cage must comply with one of Drawings 253-12, 253-13 and 253-14. The reinforcements may follow the curve of the roof.

For competitions without co-drivers, in the case of Drawing 253-12 only, only one diagonal member may be fitted but its front connection must be on the driver's side.

The ends of the reinforcements must be less than 100 mm from the junction between roll bars and Members (not applicable to the top of the V formed by reinforcements in Drawings 253-13 and 253-14).

Junction of tubes at the top of the V:

If the tubes do not join each other, the distance between them must not be more than 100 mm at their connection with the roll bar or the transverse member.

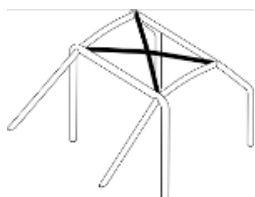

253-12

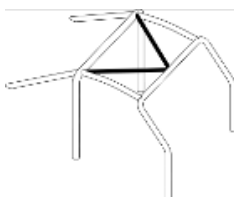

253-13

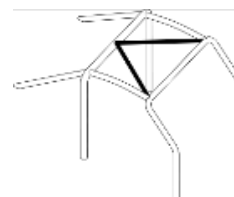

253-14

11.4.2.1.5 **Windscreen pillar reinforcement:**

It must be fitted on each side of the front roll bar (Drawing 253-15).

It may be bent on condition that it is straight in side view and that the angle of the bend does not exceed 20°.

Its upper end must be less than 100mm from the junction between the front (lateral) roll bar and the longitudinal (transverse) member.

Its lower end must be less than 100mm from the (front) mounting foot of front (lateral) roll bar (Refer Drawing 253-52 for the measurement).

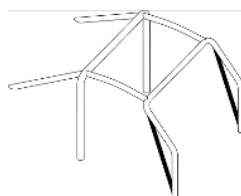

253-15

11.4.2.2.1 **Roof reinforcements:** (Drawings 253-12 to 253-14 and 253-23 to 253-24)

Only optional for cars homologated before 01.01.2005.

For competitions without co-drivers, in the case of Drawing 253-12 only, one diagonal member only may be fitted but its front connection must be on the driver's side.

Members shown in Drawings 253-23 and 253-24 may be made from two tubes.

11.4.2.2.2 **Backstay diagonals:** (Drawings 253-20 and 253-21)

The configuration of Drawing 253-21 may be replaced with that of Drawing 253-22 if a roof reinforcement complying with Drawing 253-14 is used.

11.4.2.2.3 **Front suspension mounting points:** (Drawing 253-25)

The extensions must be connected to the front suspension top mounting points.

11.4.2.2.4 **Transverse members:** (Drawing 253-26 to 253-28 and 253-30)

Transverse members fitted on the main roll bar or between the backstays may be used for the safety harness mountings in accordance with Article 253-6.2 (use of dismantable joints prohibited).

For members shown on Drawings 253-26 and 253-27, the angle between the central leg and the vertical must be at least 30°.

11.4.2.2.5 **Reinforcement of bends or junctions:** (Drawings 253-31 to 253-34)

Reinforcements must be made of tubes or bent-sheet metal with U shape complying with Article 283-8.2.14.

The thickness of the components forming a reinforcement must not be less than 1.0 mm.

The ends of the tubular reinforcements must not be more than half way down or along the members to which they are attached, except for those of the junction of the front roll bar, which may join the junction of the door strut/front roll bar;

11.4.2.2.6 **Mounting of the lifting jacks:**

For Group T1 and T3 cars, the lifting jacks may be fixed to the safety cage.

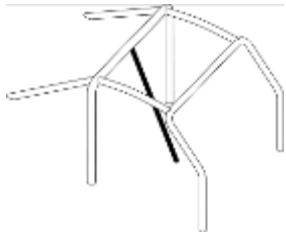

253-16

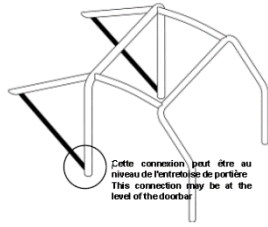

253-17

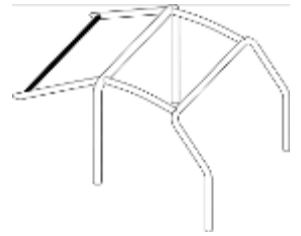

253-18

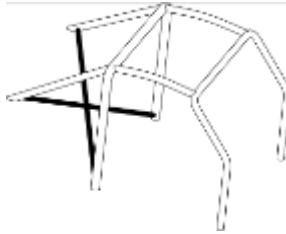

253-19

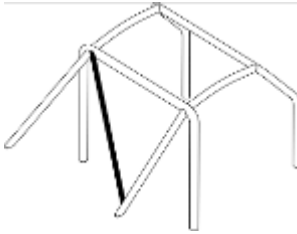

253-20

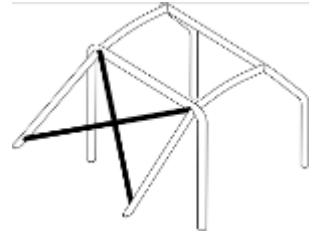

253-21

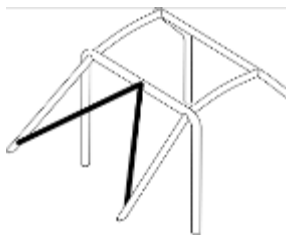

253-22

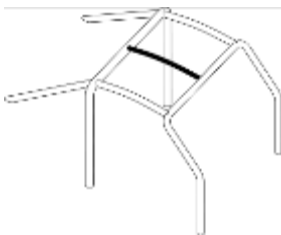

253-23

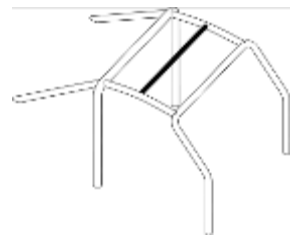

253-24

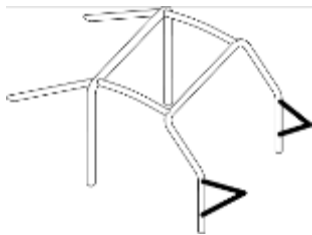

253-25

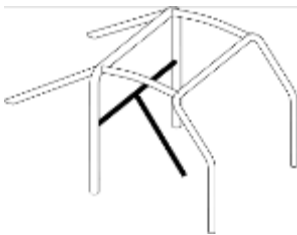

253-26

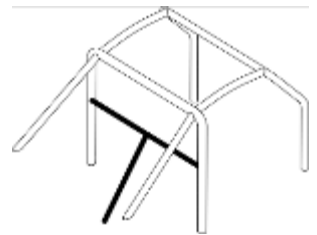

253-27

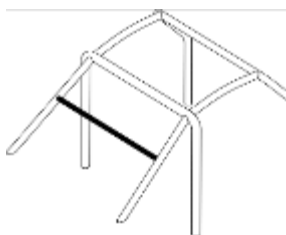

253-28

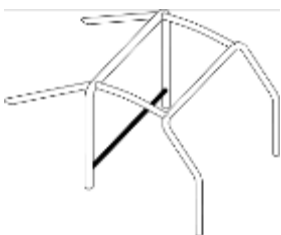

253-30

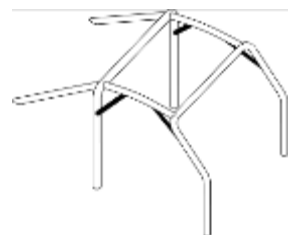

253-31



253-32



253-33

11.4.2.3 **Minimum configuration of the safety cage:**

The minimum configuration of a safety cage is defined as follows

Cars homologated	With co-driver	Without co-driver
Before 01.01.2005	Drawing 283-1A	Drawing 283-2A or symmetrical
As from 01.01.2005	Drawing 283-1B	Drawing 283-2B or symmetrical

The diagonal member may vary according to Article 283-8.3.2.1.1. Roof reinforcement may vary according to Article 283-8.3.2.1.4.

In the case of a car with a crew of three, the safety cage must comply with Drawing 283-3, with a second main roll bar situated close to the back(s) of the rear seat(s).

With regard to pick-up vehicles, the cockpit of which is not large enough to allow the fitting of the compulsory basic safety cage, it is possible to mount the roll bar(s) as per one of the Drawings 283-4 to 283-7.

This possibility is open to pick-ups only, to the exclusion of all other types of bodywork and all the points of the installation must comply with the prescriptions of the other paragraphs (including the material specifications of Article 283-8.3.3).

Drawing 283-4: one diagonal strut compulsory.

Drawing 283-5: two diagonal struts compulsory, one for the 4-point cage inside the cockpit (according to Drawing 253-5), one for the 4-point outside cage (according to Drawing 253-4 or 253-5).

Drawing 283-6: one diagonal strut compulsory (according to Drawing 253-4 or 253-5).

Drawing 283-7: two diagonal struts compulsory, one for the interior 4-point cage, one for the exterior 6-point cage.

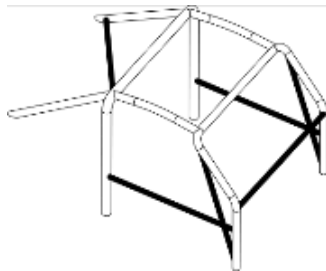

283-1A

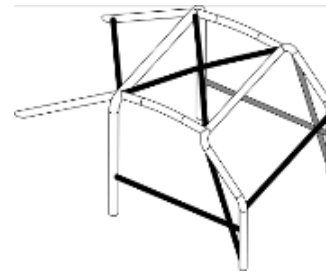

283-1B

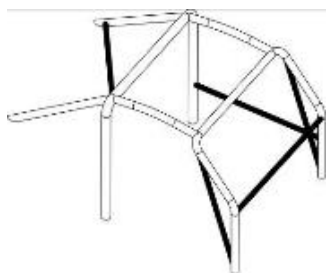

283-2A

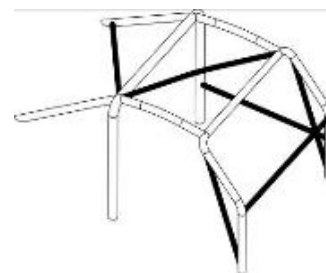

283-2B

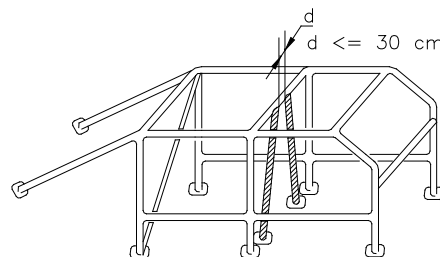

283-3

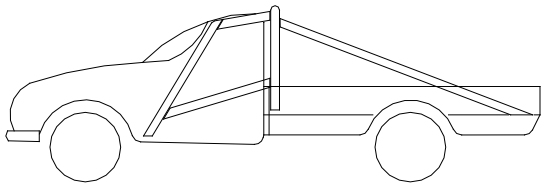

283-4

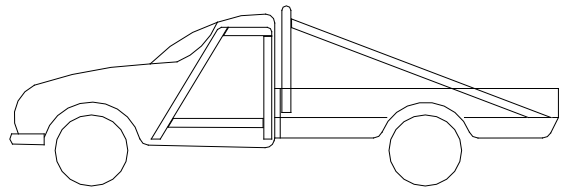

283-5

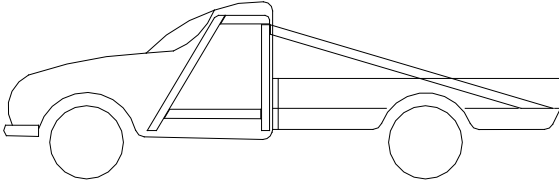

283-6

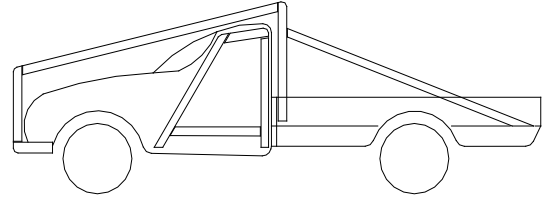

283-7

11.4.2.4 Removable members:

Should removable members be used in the construction of a safety cage, the dismantlable joints used must comply with a type approved by the FIA (Drawings 253-37 to 253-47).

The removable connections must be fitted within the extension of the axis of the tubes, and must not be offset.

They must not be welded once assembled.

The screws and bolts must have a minimum quality of 8.8 (ISO standard).

Dismantlable joints complying with Drawings 253-37, 253-40, 253-43, 253-46 and 253-47 are solely for attaching optional members and reinforcements described by Article 283-8.3.2.2, and are forbidden for joining the upper parts of the main roll bar, of the front roll bar, of the lateral half-roll bars and of the lateral roll bars.

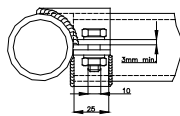

Direction d'application de la charge
Direction of applied load

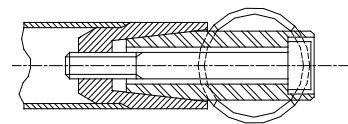
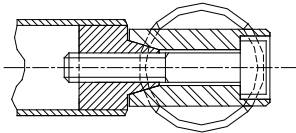
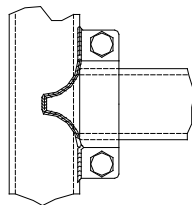

253-37

253-38

253-39

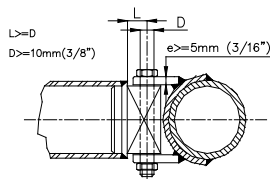

253-40

L1=L3>18mm
L2>=36mm
D=8mm

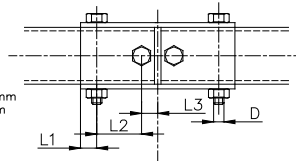

253-41

L1=L3>36mm
D=10mm

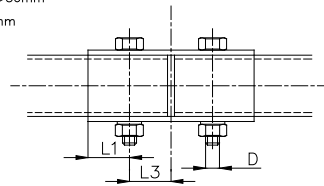

253-42

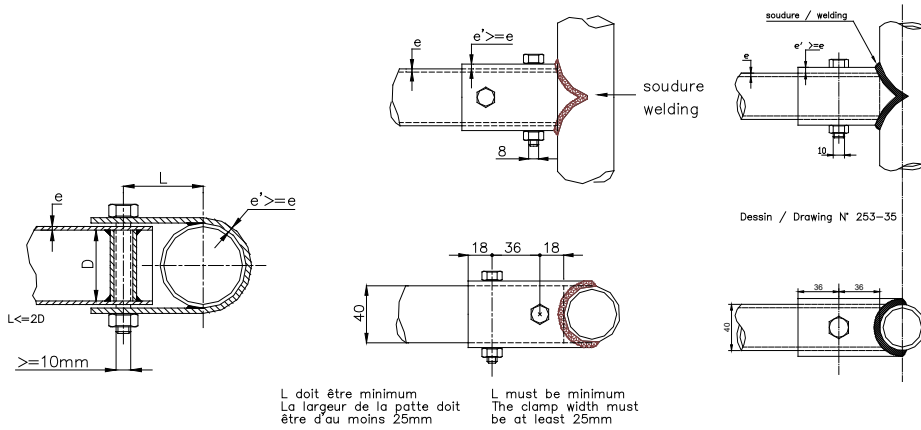

253-43

253-44

253-45

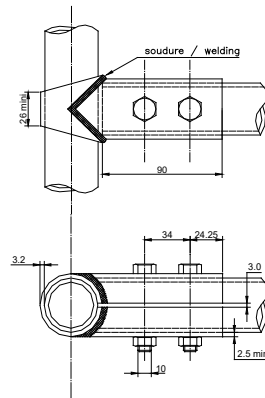

253-46

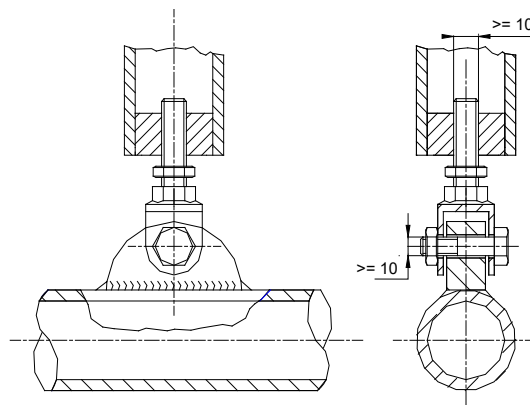

253-47

11.4.2.5 Additional constraints:

The safety cage must be entirely contained between the following limits:

- 200mm in front of the front wheel axis,
- rear wheel axis.

Nevertheless, the backstays may extend beyond this plane to be attached to the chassis.

The rear backstays on a monocoque chassis may extend beyond the rear suspension mounting points, provided that they are fixed or welded onto a hollow body of the monocoque chassis.

The rear face of the headrest subjected to the regulation load defines the position of the tube of the main roll bar which may not protrude beyond it in vertical projection.

The minimum distance between the occupants' helmets and the tubes of the safety cage must not be less than 50mm.

11.4.2.6 Mounting of Safety Cage to the bodyshell/chassis:

The safety cage must be fixed directly to the steel bodyshell or the main chassis, i.e. onto the structure to which the suspension loads are transmitted (with, if necessary additional reinforcement at the joint between the chassis and the foot of the roll bar).

Minimum mounting points are:

- 1 for each pillar of the front roll bar;
- 1 for each pillar of the lateral roll bars or lateral half-roll bars;
- 1 for each pillar of the main roll bar;
- 1 for each backstay.

To achieve an efficient mounting to the bodyshell, the original interior trim may be modified around the safety cages and their mountings by cutting it away or by distorting it.

however, this modification does not permit the removal of complete parts of upholstery or trim. Where necessary, the fuse box may be moved to enable a Safety Cage to be fitted.

Mounting points of the front, main, lateral roll bars or lateral half-roll bars: Each mounting point must include a reinforcement plate at least 3mm thick.

Each mounting foot must be attached by at least three bolts on a steel reinforcement plate at least 3mm thick and of at least 120 cm² area which is welded to the bodyshell.

For cars homologated as from 01.01.2007, the area of 120 cm² must be the contact surface between the reinforcement plate and the bodyshell.

Examples according to Drawings 253-50 to 253-56.

For Drawing 253-52, the reinforcement plate need not necessarily be welded to the bodyshell.

In the case of Drawing 253-54, the sides of the mounting point may be closed with a welded plate. Fixing bolts must have a minimum diameter of M8 and a minimum quality of 8.8 (ISO standard).

Fasteners must be self-locking or fitted with lock washers.

The angle between 2 bolts (measured from the tube axis at the level of the mounting foot cf. Drawing 253-50) must not be less than 60 degrees.

Mounting points of the backstays:
Each backstay must be secured by a minimum of 2 M8 bolts with mounting feet of at least 60 cm² area (Drawing 253-57), or secured by a single bolt in double shear (Drawing 253-58), provided it is of adequate section and strength and provided that a bush is welded into the backstay. Their mountings must be reinforced by plates.

These are minimum requirements.

In addition, more fasteners may be used, the support plates of the mounting feet may be welded to reinforcement plates, the safety cage (as defined by Article 283-8.3.1) may be welded to the bodyshell/chassis.

Special case:

Diagonal members fixed to the bodyshell (Refer Drawing 253-6) must have reinforcement plates as defined above.

For non-steel bodyshells/chassis, any weld between the cage and the bodyshell/chassis is prohibited, only the bonding of the reinforcement plate on the bodyshell/chassis is permitted.

Safety Cages equipping vehicles with a tubular or semi-tubular space frame (Groups T1 and T3) must be welded to the chassis or be an integral part of it.

The mounting points of the front, lateral, semi-lateral and main roll bars must be situated at least at the level of the cockpit floor.

At least one tube of the same section and quality must extend each foot of the roll bar downwards. Another diagonal is recommended, as well as a horizontal tube at floor level.

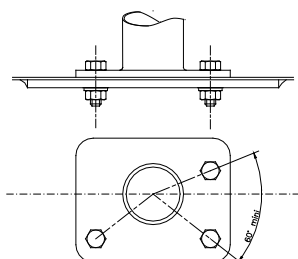

253-50

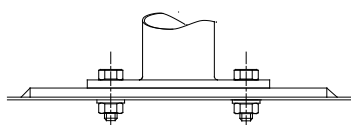

253-51

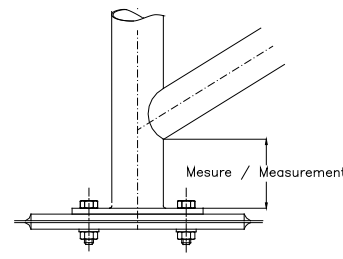

253-52

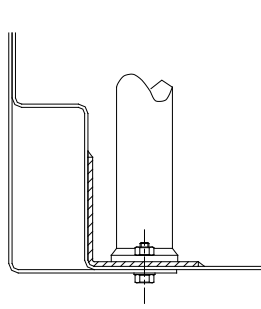

253-53

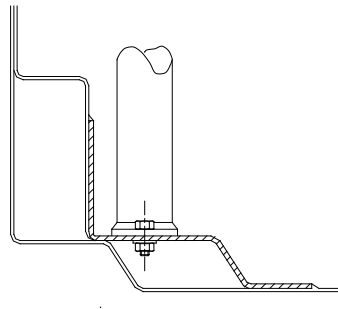

253-54

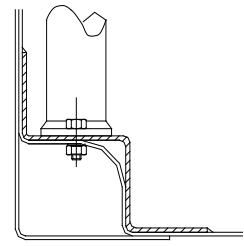

253-55

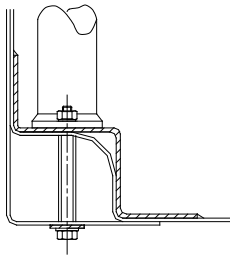

253-56

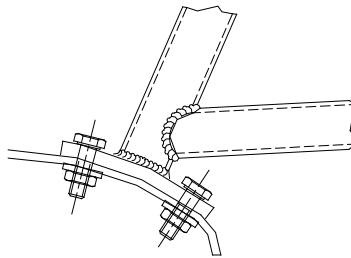

253-57

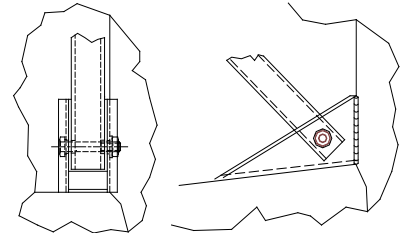

253-58

11.4.3 Material specifications:

Only tubes with a circular section are authorised. Specifications of the tubes used:

Material	Minimum tensile strength	Minimum dimensions (mm)	Use
Cold drawn seamless unalloyed carbon steel (see below) containing a maximum of 0.3 % of carbon	350 N/mm ²	45 x 2.5 (1.75"x0.095") or 50 x 2.0 (2.0"x0.083")	Main roll bar (Drawings 253-1 and 253-3) or Lateral roll bars and Rear transverse member (Drawing 253-2)
		38 x 2.5 (1.5"x0.095") or 40 x 2.0 (1.6"x0.083")	Lateral half-roll bars and other parts of the safety cage (unless otherwise indicated in the articles above)

Note:

These figures represent the minima allowed.

In selecting the steel, attention must be paid to obtaining good elongation properties and adequate weldability. The tubing must be bent by a cold working process and the centreline bend radius must be at least 3 times the tube diameter.

If the tubing is ovalised during bending, the ratio of minor to major diameter must be 0.9 or greater. The surface at the level of the bends must be smooth and even, without ripples or cracks.

11.4.4 Guidance on welding:

These must be carried out along the whole perimeter of the tube. All welds must be of the highest possible quality with full penetration and preferably using a gas-shielded arc.

Although good external appearance of a weld does not necessarily guarantee its quality, poor looking welds are never a sign of good workmanship.

When using heat-treated steel, the special instructions of the manufacturers must be followed (special electrodes, gas protected welding).

11.4.5 Protective padding:

Where the occupants' bodies could come into contact with the safety cage, flame retardant padding must be provided for protection.

Where the occupants' crash helmets could come into contact with the safety cage, the padding must comply with FIA standard 8857-2001, type A (Refer technical list n°23 "Roll Cage Padding Homologated by the FIA") and must be permanently fixed to the cage. Application: For all categories.

VEHICLE CLASSES

12. SPECIAL VEHICLE CATEGORY AND CLASSES

NOTES:

1. Competitors contemplating the purchase or construction of a new vehicle for any of classes FIA-T1, A, B, P or G must ensure that the specifications and design is acceptable to *the SA Rally-Raid Championship* and acceptance has been confirmed in writing and signed by both the CEO and the Technical Delegate. Refer Art 1.4 and 1.7.
2. For safety reasons crews must consist of two persons to compete in National Championship Events.

12.1 GENERAL REGULATIONS – ALL SPECIAL VEHICLE CLASSES

- 12.1.1 No racing vehicle may have any forward or rearward protruding metal parts past the front and rear most transverse metal structure.
- 12.1.2 Vehicles must be fitted with sturdy towing eyes front and rear, in a visible and accessible position, painted red or orange.
- 12.1.3
- i) Titanium or magnesium materials are not allowed, unless they are fitted as standard parts on Commission Approved (CA) assemblies.
 - ii) Carbon fibre and Kevlar materials are not allowed other than for specific aesthetic use only, e.g. one layer for dashboard panels, air cleaner assemblies, air ducts, selected body panels. Multi layers of Kevlar may be used for genuine stone protection areas.
- 12.1.4 Air cleaner system free and position free. Should air be passed through the passenger compartment only a pipe with a maximum diameter of 110mm may be used. Restrictors must be in the engine compartment. Refer Art 3.2
- 12.1.5 No traction-, launch- or vector control, ABS, *electronically controlled active suspension*, or any closed-loop electronic control system whatsoever, except engine management, may be used. *No pneumatic or hydraulic suspension allowed, only mechanical. Steering must be direct mechanical with hydraulic or electrical assistance.*
- 12.1.6 An on-board tyre “deflation/inflation system” *may only be used in class FIA.*
- 12.1.7 An on-board vehicle jacking system may only be used in class FIA.
- 12.1.8 Telemetry is not permitted, but on board data logging is allowed.
- 12.1.9 Fasteners used throughout the vehicle are free. Ferrous materials only.
- 12.1.10 On-board fire protection system is recommended for all vehicles competing in this category. Refer Art 6.
- 12.1.11 The use of electronic devices for communication (two-way radios/cell phones/intercoms) purposes are allowed. Only RallySafe and the *SA Rally-Raid* specified GPS will be allowed for route finding.
- 12.1.12 The vehicle shall be constructed to accommodate a crew of two.
- 12.1.13 All spare wheels must be securely fastened when on the vehicle.
- 12.1.14 The safety cage, body and cockpit of the vehicle must be built so that it is possible to allow the crew to escape in an emergency. Refer Art 11. The crew must be able to exit the vehicle unaided within 7 seconds on either side of the vehicle. The Technical Delegate may request test runs to prove this.
- 12.1.15 *Refer SSR Part 2 art 2.11*
- 12.1.16 Speed limits: A general speed limit will be applicable to all classes in all events. The maximum speed for classes A, B and P will be *170 km/h*. The maximum speed for class G will be 140 km/h. These speed limits may not be exceeded. *Refer SSR 308.*
- 12.1.17 *Fuel Refer Part 2 art. 2.11*
Fuel tanks must have sufficient capacity to complete 220 kilometres of racing .

12.2 Reserved

12.3 CLASS A. Special Vehicles - Two Wheel Drive

- 12.3.1 There are no restrictions on chassis or suspension in this class, *but art 12.1 takes precedence.*
- 12.3.2 The body fitted to a vehicle competing in this class may not resemble a body fitted to a production vehicle, and shall not display any current production vehicle brand name. *No obvious aerodynamic assistance will be allowed.*
- 12.3.3 **Engines:**
All engines for class A must be registered in the Technical Passport. New engines must be commission

approved. Only normally aspirated (NA), standard Gp N petrol engines with capacity not exceeding 6300 cc will be allowed.

No modified engines will be allowed after 31 December 2018. Engines not complying with the regulations may be allowed to run under dispensation with balance of performance applied.

12.3.3.1 Commission Approved engines:

- i) Chevrolet LS 3 crate engine, part no. 19369326, max capacity 6162 cc, max compression ratio 10,7:1, standard inlet manifold and throttle body. No engine modifications allowed.

12.3.3.2 Reserved

12.3.3.3 Exhaust manifold and systems are free, but must be made from steel, and conform to Art. 4.

12.3.4 **Transmission:**

Vehicles are restricted to two wheel drive. Gearbox and other drive details are free, but must be mechanical engine to wheel. No electrical, pneumatic or hydro-static drives are allowed. Torque converters are allowed.

12.4 **CLASS B. Special Vehicles - Two Wheel Drive**

12.4.1 Engines:

- 12.4.1.1 - any normally aspirated four-cylinder petrol engine with a cubic capacity of no greater than 2050cc may be used. The engine must originate from any series production car or commercial vehicle that is available from retail engine outlets in South Africa, and the engine must be clearly recognisable as such.
- engine modifications permitted: The original cylinder head, cylinder block and crankshaft must be retained otherwise modifications are unrestricted.

12.4.1.2 The Nissan SR20 VVL Neo engine may be used.

12.4.1.3 Rotary engines are not allowed in class B.

12.4.2 There are no restrictions on chassis, body, suspension in this class, but crew must consist of 2 persons. Single seater Class B vehicles are permitted in Regional Championship racing.

12.4.3 There are no restrictions on induction air or weight in this class.

12.4.4 **Transmission:**

Vehicles are restricted to two wheel drive. Gearbox and other drive details are free, but must be mechanical engine to wheel. No electrical, pneumatic or hydro-static drives are allowed. Torque converters are allowed.

12.5 **CLASS P. Special Vehicles - Two Wheel Drive**

12.5.1 There are no restrictions on chassis or suspension in this class, *but art 12.1 takes precedence.*

12.5.2 The body fitted to a vehicle competing in this class may not resemble a body fitted to a production vehicle, and shall not display any current production vehicle brand name. *No obvious aerodynamic assistance will be allowed.*

12.5.3 **Engines:**

All engines for class P must be registered in the Technical passport. New engines must be Commission Approved (C.A.) Only normally aspirated (NA), standard Gp N petrol engines will be allowed.

12.5.3.1 Commission Approved engines:

- Gp N standard, normally aspirated, 6 cylinder petrol engines with a cubic capacity of not greater than *4300 cc*. The engine must originate from any production car or commercial vehicle that is available from retail outlets in South Africa, and the engine must be clearly recognisable as such.
- engines must retain the original unmodified intake manifold. The throttle body is free but must retain the standard throttle valve diameter. It may be converted from fly by wire to mechanical operation and vice versa.
- The fitting of a Gp N standard 4000 cc Lexus engine 1UZ-FE V8 engine *and the Gp N std 4300 cc Lexus 3UZ-FE V8 engine is allowed.*

12.5.3.2 Exhaust manifold and systems are free, but must be made from steel, and conform to Art. 4

12.5.4 **Transmission:**

Vehicles are restricted to two wheel drive. Gearbox and other drive details are free, but must be mechanical engine to wheel. No electrical, pneumatic or hydro-static drives are allowed. Torque converters are allowed.

- 12.6 CLASS G (SxS)**
- 2.6.1 SPORTING REGULATIONS: CLASS SIDE BY SIDE (SxS)**
- 12.6.1.1 Class G (SxS) will fall into the Category Special Vehicles.
- 12.6.1.2 The SxS class will use "G" numbers, these are to be obtained from Charmaine Fortune (082 991 0011).
- 12.6.1.3 SSR 12.6 must be read in conjunction with the Cross Country SSR's Parts 1, 2 *and art 12.1 which takes precedence where included.*
- 12.6.1.4 All Class SxS vehicles must comply with the SxS technical regulation
Art 12.6.2. Vehicle Technical Regulations: Class Side by Side (SxS)-MSA **OR**
Art 12.6.3 Vehicle Technical Regulations: Class Side by Side (SxS)-FIA T3 and T4
- 12.6.1.5 **BALANCE OF PERFORMANCE**
Both classes may be subject to Balance of Performance measures. The parameters turbo boost, intake restrictors, race weight, maximum engine rpm, but not limited to will be used to control performance parity. Refer Cross Country SSR's Part 2: art 3.
- 12.6.1.6 **Crew**
The vehicle shall always race with two crew members appropriately licensed by MSA.
- 12.6.1.7 **Maximum speed**
The maximum speed shall be limited to 140 km/h. The onus is on the competitors to set their ECU speed limits to the maximum allowed, with a safe margin. Refer SSR Part 1: Art 306 [iv] g)
- 12.6.1.8 **Weight**
The minimum weight shall not be less than 900 kg when weighed at any time during the event. Weighed with one spare wheel. For method of weighing, refer SACCS SSR's Part 2.3.1.
- 12.6.1.9 **Number Board**
All vehicles must bear the MSA allocated competition numbers on the number panels as detailed in Part 1: SSR 301 [iii]. A durable competition number panel 250(h) x 350(w) mm must be permanently fitted high on both rear sides of the vehicle where it is clearly visible to marshals and spectators. The panel must be protected against branches sweeping the side of the vehicle. The onus is on the competitor to ensure that the competition numbers are always visible and legible.
- 12.6.2 VEHICLE TECHNICAL REGULATIONS: CLASS SIDE BY SIDE (SxS)-MSA**
- 12.6.2.1 **Vehicles**
- The Production Recreational Vehicle class consisting of mass produced four-wheeled SxS vehicles, commercially available, imported by recognised vehicle importers.
 - Main vehicle dimensions based on T3/T4:
 - The maximum width of the bodywork without rear view mirrors and/or spare wheels: 1900 mm.
 - Wheelbase: that of the reference vehicle ± 50 mm.
 - Front and rear axle width measured at vertical wheel centre not to exceed: 1900 mm.
 - Front and rear overhangs: identical to the reference vehicle ± 50 mm (spare wheels, mudflaps and their supports not included).
- 12.6.2.2 **Engine**
- Naturally aspirated or turbo, petrol or diesel, engines.
 - The engine shall be the OEM unit from the applicable vehicle, mounted in the standard position. The engine mountings may be reinforced.
 - The engine shall be in standard OEM Gp N trim. Refer SACCS SSR's Part 2: art 2.1
 - The engine fuel and breathing system:
 - i) The Can-Am ECU may be used, or any single ECU which is freely commercially available over the counter or from a widely published catalogue.
 - ii) The fuel injection system, injectors, fuel rail, high pressure fuel pump, fuel pressure regulator, pipes must remain standard 2020 OEM. Older cars may be updated to the 190 hp 2020 injector and high pressure fuel pump.
2017 to 2019 CanAm injector part no: 420874845. 2020 to 2021 CanAm injector part no: 420874858 2017 CanAm fuel pump part no: 709000836. 2020 CanAm fuel pump part no: 709001057.
The CanAm specified maximum fuel pressure is 450 ± 14 kPa. The pressure regulator is an integral part of the fuel pump, and may not be modified. There may be no connection between the fuel pressure regulator and the inlet manifold or anywhere else. No additional pumps, regulators, accumulators, etc., will be allowed in the fuel system. A connection point for a fuel pressure gauge must be provided on the fuel rail or fuel lines as required by the TC.

- iii) No water, gas or any substance may be injected into the engine air intake at all. Only clean atmospheric air.
 - iv) The inlet manifold and throttle body assembly must remain standard OEM. Throttle valve diameter is 46mm.
 - v) Turbochargers
 - Pre-2020 cars may be upgraded to the 2020 190 hp specification Rotax turbocharger which may not be exceeded.
 - Specification 2020 OEM Rotax turbocharger:
 - Rotax part no: 893733
 - compressor wheel:
 - inducer diam. 36,4mm
 - exducer (taper tip) diam. 39,6mm
 - number of blades 6
 - compressor housing:
 - inlet diam. (smallest) 37,5mm
 - outlet diam. tba.
 - turbine wheel:
 - inducer diam. tba.
 - exducer diam. tba.
 - number of blades. 11.
 - turbine housing:
 - inlet diam. (smallest) tba.
 - outlet diam. tba.
 - The Standard OEM Rotax turbocharger may be repaired to the following specification from Stallion Turbo's, Hercules, Pretoria. Repair may only be done after damage inspection and written approval by the sa Rally-Raid Technical Delegate.
 - Specification Stallion refurbished Rotax turbocharger:
 - compressor wheel, 11 blade:
 - inducer diam. 40,0 mm
 - exducer (taper tip) diam. 54,5 mm
 - exducer (base) 50,1 mm
 - compressor inlet housing diam. 41,0 mm
 - turbine wheel and housing. t.b.a.
 - vi) Holes drilled for sealing, refer SSR's Part 2: art 3.2.7
 - vii) All engine management sensors must be standard OEM, functional and operational. The following sensors may be added in addition: 3 temperature; 1 pressure; 1 fuel level.
 - Cooling system water radiators may be upgraded and relocated. Original OEM standard oil cooler must be used. Water and oil lines may be changed for relocation, but diameters may not change. Air ducting and air fans may be changed or added. Fuel cooling not allowed. Charge air cooler single OEM standard. Upgrade to single 2020 CanAm charge air cooler will be allowed. Part no 07800840. OEM water pump to remain in place, unmodified and operational. Additional pumps may be added externally from the engine in the lines.
 - Air filter and ducting is free upstream of the throttle body (NA) or upstream of the turbo inlet.
 - Exhaust system. Free after turbo. Exhaust exit must be horizontal or slope upwards, not protrude beyond the vertical projection of the car, be higher than 500 mm from ground level.
- Refer SSR's Part 2, Art 4.

12.6.2.3

Transmission / Drive Line

- Drive 2x4 or 4x4.
- The gearbox, differentials, propshaft and installation shall be the standard OEM units from the applicable vehicle, mounted in the standard OEM position. Mountings may be reinforced. The driveshafts are free, but must be steel, and must fit into the standard driveline without any modifications to the rest of the driveline.
- The CVT belts are free, but must be commercially available from a dealer catalogue. The ratio shift parameters may be modified. Clutch discs may be upgraded with parts from a series vehicle or from a catalogue of commercially available competition parts. Additional cooling air to the CVT may be provided.

12.6.2.4 **Braking System**

The braking system is free, provided that:

- it is activated and controlled only by the driver.
- it includes at least two independent circuits operated by the same pedal. Between the brake pedal and the calipers, the two circuits must be separately identifiable, without any interconnection other than the mechanical braking force balancing device, which may be a balance bar or the OEM tandem dual piston master cylinder.
- the pressure is identical on the wheels of the same axle.
- the calipers must come from a series vehicle or from a catalogue of commercially available competition parts with a maximum of 4 pistons.
- the discs must come from a series vehicle or from a catalogue of commercially available competition parts. The maximum diameter may not exceed 330 mm.
- if standard vehicle is fitted with hand brake it should stay, as well as actuation system, without modification.

12.6.2.5 **Electrical System**

The electrical system is free provided it complies with the safety standards as required in the road ordinance and SACCS SSR's Part 2: art 8.

12.6.2.6 **Suspension and Steering**

- The suspension stroke at the wheel centre is limited at 560 mm (front) and at 610 mm (rear).
- The suspension arms are free, but must fit in the standard chassis mounting points without any modifications, and must be the same length from pivot point to pivot point, i.e. no geometry changes.
- Uprights, wheel bearings and hubs must be OEM from the standard vehicle, or from a catalogue of commercially available competition parts. Suspension pivot points must remain in the OEM standard position.
- The original OEM dampers must be retained but valving may be changed. Only different size shims and number will be allowed.
- Suspension springs are free. Only one damper and spring per wheel is allowed.
- All the suspension mounting points on the chassis must remain in the standard position, but may be reinforced.
- The adjustment of the springs and/or dampers from the cockpit is forbidden. It must only be possible when the car is stationary and only with the use of tools. The damper adjustment device must be situated on the damper or its gas reservoir.
- Any connections between dampers are forbidden. Closed loop control systems – electric, pneumatic or hydraulic that result in interconnecting front to rear or left to right, or adjust spring and damping parameters, or adjust ride height on the move, are not allowed.
- Steering gearbox standard, or from a catalogue of commercially available competition parts, but must bolt on to the chassis in the standard position. The power-steering OEM principle must stay standard as well as the mechanism.
- Only one antiroll bar per axle is permitted. The adjustment of the antiroll bars from the cockpit is forbidden. The antiroll bar system must be exclusively mechanical, with no activation or deactivation possible. Any connections between front and rear antiroll bars are forbidden. The diameter of the antiroll bars is free. Anti-roll bars may be removed.

12.6.2.7 **Wheels and tyres**

- The maximum rim diameter is 15 inches, the maximum inflated tire diameter is 30 inches (770 mm). [FIA App J 286 and 286A art 11]
- The wheels do not have to be of the same diameter. Motorcycles wheels are not allowed.
- Rims may be made out of aluminium or steel. Wheel spacers are not allowed. Central wheel nuts are not allowed.
- The use of any system on board for inflating / deflating the tires when the car is in motion is not allowed.
- The vehicle must be able to carry two full-sized spare wheels but may race with one only. Position of spare wheels is free, but must have sturdy mountings.

12.6.2.8 **Chassis**

- Standard production chassis of the vehicle is to be retained.
- Chassis may be reinforced, but no part of the original chassis rails and cross members may be removed from the floor structure.
- Mounting points for roll cage, fuel tanks and other items may be added.
- Roll cage shall be fitted to comply as a minimum with MSA GCR 239.

- Seats and safety harnesses shall be fitted to comply with *the SA Rally-Raid Championship SSR's Part 2: art 9&10.*
- A sturdy protection must be fitted over the front propshaft under the floor in the tunnel to protect the feet and legs of driver and navigator in the event of propshaft failure or crash. A steel tube, diameter larger than the propshaft, wall thickness 2,5 mm minimum, can be cut in half along the centreline and attached to the chassis tubes front and rear. Front attachment at the front carrier bearing and rear attachment at the rear carrier bearing or a chassis tube behind the seat backs. Alternatively rings fabricated out of 30 x 5 steel flat bar can be used. Cut the rings in half and add ears to bolt the two halves together. Attach the front ring at just behind the front carrier bearing and the rear ring to the chassis behind the seat backs. The two universal joints must be outside the protection. Only the propshaft tube inside. Split the rings to fit the propshaft. Refer also FIA App J Art 286.5.13

12.6.2.9

Body

- Standard production body of the vehicle is to be retained. Cut-outs may be made to fit the safety cage and allowed modifications. No aerodynamic aids will be allowed, unless it is fitted as standard on the showroom floor of the specific model.

12.6.2.10

Fuel System

- The fuel system shall retain the standard basic layout of the production vehicle but may be modified whilst complying with GCR 257.
- Two additional fuel tanks may be fitted to increase the fuel capacity to 130 litre maximum, which should allow 220 race km's without refueling.
 - a) The additional fuel tanks shall be fitted under the two seats, each fitted with a lift pump to feed fuel separately to the standard Can-Am fuel tank. The lift pumps shall be regulated to switch off when the standard tank is full to prevent overflowing through the breather. The lift pumps shall be connected via the ignition switch, each with its own switch, fuse and relay.
 - b) The fuel tanks to be fabricated using 3mm thick 5000 or 6000 series aluminium. Welding to be done by a certified aluminium welder.
 - c) The fuel tanks shall be mounted with the lowest part of the tank not lower than 10mm from the underside of the chassis tubes. The fuel tanks must have a minimum of 10mm clearance between tank and any part of the chassis surrounding it. Cars with fuel tanks not complying will have to be modified.
 - d) The tanks shall be properly tied down by two 50mm x2mm steel straps with two M8 x 8.8 bolts each side of the strap. The tanks may alternatively be mounted by weld-on brackets if steel strap mounting is not feasible. At least 4 mounting brackets are required, using M8 x 8.8 bolts. Rubber bushes may be mounted in-between to absorb vibration and chassis flexing.
 - e) The complete area underneath the tanks from the pedal box to the rear of the tanks and full width to be covered by 3mm Hardox 450 steel sheet (www.ssab.co.za) or equivalent. The protection plates to be bolted by M8 x 8.8 bolts suitably spaced. Drain holes to be made in the four corners of the plate to allow spilt fuel to drain from the floor. The standard Can-Am heavy duty (10 mm thick) composite floor protection plate may also be used, unmodified. The area between the tank and the floor plate must be completely filled with a sheet of Sondor closed cell Neoprene 25. The fuel tank may not be in direct contact with the floor plate or chassis anywhere at any time.
 - f) The fuel filler/s must be inside the safety cage envelope, not to be touched by the ground surface when the vehicle is lying on its side. The filler/s must be as far away as possible from the crew, and also not near the engine. There may be no holes in the filler caps and the cap seals must be fuel tight.
 - g) The fuel tank breather/s, including the standard plastic tank to be routed from the top of the highest fuel tank to under the roof, across to the opposite side of the car, and then down to below the bottom of the lowest tank. All the way inside the safety cage for protection.
 - h) The filling of tanks with a fire retardant agent, eg. ATL SF 103 or similar, will be encouraged.
 - i) Only braided steel hoses with matching screw fittings will be allowed to convey fuel and oil through the passenger compartment. Hose clamp fittings will not be allowed. All fuel hoses to be properly tied in place to prevent pinching and chafing.
 - j) The standard unmodified Can-Am bulkhead engine cover, fastened, including all inspection covers, as per Can-Am service instructions, shall at all times be fitted in the crew compartment behind the seats to provide engine compartment fire protection for the crew. No additional air inlet duct or inspection hatches will be allowed.
 - k) The fuel tanks and ancillaries shall be mounted securely in terms of safety to the satisfaction of the *SA Rally-Raid* Technical Delegate.

- 12.6.2.11 **Auxiliaries**
- All vehicles shall be fitted with a Garmin GPS and RallySafe complying with the *SA Rally-Raid Championship* SSR's Part 1: 300 [x] in its entirety.
 - All vehicles shall display competition numbers complying with the SACCS SSR's Part 1: 301 [iii] and art 12.6.1.9
 - All vehicles shall carry emergency equipment as per *SA Rally-Raid Championship* SSR's Part 1: 300 [viii] and [ix] and 301 [iv] to the satisfaction of the Medical Officer.
 - All vehicles shall have window nets, mirrors and cutters to comply with *SA Rally-Raid Championship* SSR's Part 2: art 5 to the satisfaction of the *SA Rally-Raid Championship* Technical Delegate.
 - All vehicles shall have batteries, lighting and electrical to comply with the *SA Rally-Raid Championship* SSR's Part 2: art 8 to the satisfaction of the *SA Rally-Raid* Technical Delegate.
 - Fire extinguishers: The *SA Rally-Raid Championship* SSR's Part 2: art 6 is mandatory. Only the equipment as specified will be acceptable.

12.6.3 **VEHICLE TECHNICAL REGULATIONS: CLASS SIDE BY SIDE (SxS)-FIA**

- 12.6.3.1 Vehicles that conform entirely to FIA App J Art 286 Specific Regulations for Lightweight Prototype Cross Country Vehicles (Group T3), all applicable FIA regulations, prescriptions and bulletins, including General Prescriptions as amended by FIA.
- 12.6.3.2 Vehicles that conform entirely to FIA App J Art 286A Specific Regulations for Lightweight Series Production Cross-Country Side-by-Side Vehicles (Group T4) all applicable FIA regulations, prescriptions and bulletins, including General Prescriptions as amended by FIA.
- 12.6.3.3 *SA Rally-Raid Championship* retains the right to apply balance of performance measures should conditions require. Refer art 12.6.1.5 BoP.

~~12.7~~ **~~CLASS - FIA T1 VEHICLES~~**

- ~~12.7.1~~ *This category will conform entirely to FIA App J Art 285. Specific Regulations for Modified Cross Country Cars (Group T1 ; T1+ and T1.2) and all applicable FIA regulations, prescriptions and bulletins.*
- ~~12.7.2~~ *In class FIA T1 the FIA regulations take precedence, unless a SSR specifies a different requirement for the FIA.*

13. **PRODUCTION VEHICLE CATEGORY AND CLASSES.**

NOTES:

1. Competitors contemplating the purchase or construction of a new vehicle for any of classes *FIA T1+, T1, T1.2* T, S, D or E must ensure that the specifications and design is acceptable to *the SA Rally-Raid* and acceptance has been confirmed in writing and signed by both the CEO and the Technical Consultant. Refer Art 1.4,1.5, 1.7.
2. For safety reasons crews must consist of two persons to compete in National Championship Events

13.1 **GENERAL REGULATIONS – ALL CLASSES**

- 13.1.1 Any form of aerodynamic device or variation in body shape that may be construed as an aerodynamic device to provide extra down force or decrease drag is not allowed.
- 13.1.2 *Reserved*
- 13.1.3 Skid plates may be added to protect steering, suspension, engine, transmission, diff housings and fuel tanks.
These skid plates may only be made of steel, aluminium alloy or composite. Refer 13.1.9 ii).
- 13.1.4 Additional fluid coolers may be added for engine oil, transmission oil, differential oil and power steering fluid.
- 13.1.5 Mud flaps fitted to competing vehicles may be fitted behind the front and/or rear wheels only, may not be wider than 40cm and must be more than 100mm above the ground stationary, ready to race.
- 13.1.6 Bush deflector bars or cables may be added between the front fenders and the cab roof.
- 13.1.7 Side protection bars may be added provided they do not protrude past the overall width of the vehicle.
- 13.1.8 Vehicles must be fitted with sturdy towing eyes front and rear, in a visible and accessible position, painted red or orange.
- 13.1.9
- i) Titanium or magnesium materials are not allowed, unless they are fitted as standard parts on the homologated production vehicle.
 - ii) Carbon fibre and Kevlar materials are not allowed other than for specific aesthetic use only, e.g. one

layer for dashboard panels, air cleaner assemblies, air ducts, inner door closure panels, selected body panels.

Multi layers of Kevlar may be used for genuine stone protection areas.

- 13.1.10 No traction-, launch- or vector control, ABS, *electronically controlled active suspension*, or any closed-loop electronic control system whatsoever, except engine management, may be used. *No pneumatic or hydraulic suspension allowed, only mechanical. Steering must be direct mechanical with hydraulic or electrical assistance.*
- 13.1.11 Air cleaner system free and position free. Should air be passed through the passenger compartment only a pipe with a maximum diameter of 110mm may be used. Restrictors must be in the engine compartment. Refer Art 3.2
- 13.1.12 An on-board tyre “deflation/inflation system” may *only be* used in class *FIA (4x2)*
- 13.1.13 An on-board vehicle jacking system *may only* be used *in class FIA.*
- 13.1.14 Telemetry is not permitted, but on board data logging is allowed.
- 13.1.15 Fasteners used throughout the vehicle are free and production fasteners may be replaced by alternatives. Ferrous materials only.
- 13.1.16 On-board fire protection system is recommended for all vehicles competing in this class. Refer Art 6.
- 13.1.17 The use of electronic devices for communication (two-way radios/cell phones/intercoms) purposes are allowed.
Only RallySafe and the *SA Rally-Raid* specified GPS will be allowed for route finding.
- 13.1.18 The vehicle shall be constructed to accommodate a crew of two.
- 13.1.19 *Tyres for classes T and S must be from the Commission Approved list, but the number is free.*
Tyres for classes D and E are free. *Tyres for FIA - refer art 13.2*
- 13.1.20 The use of well-designed and manufactured steering multipliers is allowed on any Cross Country Racing vehicle.
- 13.1.21 Re-engined vehicles with engines complying to Art 13.3.2 will be allowed with the written permission of the *SA Rally-Raid Championship*
- 13.1.22 All spare wheels must be securely fastened when on the vehicle.
- 13.1.23 A standard production homologated safety glass windscreen must be used.
If the front windscreen is glued or otherwise permanently fixed, then it must be possible to remove the side windows or doors without tools, to allow the crew to escape in an emergency. Driver and navigator must be able to exit the vehicle unaided within 7 seconds on either side of the vehicle.
All other glass may be replaced with polycarbonate material, Lexan F2000 sheet or equivalent, min thickness 3 mm. Refer SSR Part 2 Art 5.
- 13.1.24 *Fuel Refer Part 2 art. 2.11*
Fuel tanks must have sufficient capacity to complete 220 kilometres of racing .
- 13.1.25 *Reserved.*
- 13.1.26 Speed limits: A general speed limit will be applicable to all classes in all events *including class FIA.* The maximum speed for classes FIA T, S, D and E will be *170km/h.* These speed limits may not be exceeded. Exceeding the speed limit as indicated on RallySafe will be penalised. *Refer SSR 308.*

13.2 CLASS - FIA T1 VEHICLES

- 13.2.1 This category will conform entirely to FIA App J Art 285. Specific Regulations for Modified Cross Country Cars *Group T1 , T1+ and T1.2) which includes classes T1.1 (4x4) and T1.1+ (4x4), as well as T1.2 (4x2)* and all applicable FIA regulations, prescriptions and bulletins.
- 13.2.2 In class *Category* FIA T1 the FIA regulations take precedence, unless a SSR specifies a different requirement for the FIA.
- 13.2.3 The Nissan T1.1 vehicles will be allowed to run the VK56 5600cc engine with 4580kg *1850kg* minimum weight, and the VK50 engine with a 38mm restrictor.

13.3 CLASS T - PRODUCTION VEHICLES, 5 LITRES

13.3.1 **Reserved.**

13.3.2 **Engines:**

- 13.3.2.1
- all Class T Vehicles must be fitted with Group N specification engines only.
 - normally aspirated (NA) petrol engines, capacity not exceeding 5020cc.
 - all normally aspirated engines must retain the original inlet manifolds and throttle bodies as per Group N specification.

The inlet manifolds must remain unmodified. The addition of a spacer, maximum thickness 70 mm,

between the inlet manifold and the cylinder head is allowed. All unused apertures must be sealed completely.

No breather systems allowed in between the restrictor and the cylinder head.

Electronic throttle bodies may be converted to mechanical actuation and vice versa, but the air passage and butterfly valve sizes must remain original.

13.3.2.2 Exhaust systems are free, but must be made from steel, and conform to Art. 4.

13.3.2.3 Reserved

13.3.2.4 Engine position. The intersection of the front face of the cylinder block and the crankshaft centreline must be more than 100 mm forward of the front axle centreline.

Engine height to be governed by the Commission Approved front differential housing mounted generally on the front axle centreline, and the engine mounted over this differential. See Addendum 3.

13.3.2.5 Modifications allowed to external engine ancillaries:

- Exhaust manifolds for normally aspirated engines and exhaust systems are free but must be made from ferrous material. Refer Art 4.
- Flywheel to be original, or made of ferrous material only, otherwise free.
- Engine mountings free. The attachment of the mountings to the engine block must be to the standard position.
- Engine management system free. The use of a gear cut system (engine cut to aid gear change) is authorised. Refer Art 13.1.10.
- All unused external bolt-on ancillaries may be removed from the engine e.g. air conditioner pumps, heater pipes, etc.

13.3.2.6 Power steering pumps and alternator as well as their brackets/mountings free.

13.3.3 **Transmission/Driveline:**

13.3.3.1 **General:**

Only 4x4 drivelines are allowed. Mechanical drive only. No electric, hydraulic, pneumatic drives allowed. Hydraulic torque converters allowed.

13.3.3.2 **Gearbox**

- free from the marque with production ratio's only, or
- Commission Approved gearbox. Refer C.A. list. Ratios are free.

13.3.3.3 **Transfer gearbox (4 WD)**

- free from the marque with internals free, or
- Commission Approved transfer gearbox. Refer C.A. list.

13.3.3.4 **Clutch**

Twin plate clutches may be used, no carbon components are allowed.

13.3.3.5 **Front Axle/Differential assembly (4WD)**

- original units may be retained, internal components free, or
- Commission Approved front axle/differential assembly.

13.3.3.6 **Rear Axle/Differential assembly**

- original units may be retained, internal components free, or
- Commission Approved beam rear axle/differential assembly. Ratio free.

13.3.3.7 **Prop shafts**

- free, ferrous material only.

13.3.3.8 **Constant Velocity Joints (CV)**

- original CV joints, or
- outer and inner CV joints Commission Approved.

13.3.3.9 **Driveshaft's**

- free, ferrous material only.

13.3.4 Brake System

13.3.4.1 Original brake system may be used in its entirety, or

13.3.4.2 A racing pedal box system is authorised. The front-rear brake force balance may only be changed Manually via a cable connected to the "balance bar" in the pedal box, turned by hand by the driver or navigator.

No ABS or similar electronic control systems allowed.

13.3.4.3 The original hand brake system may be removed. The fitting of a hydraulic hand brake system is authorised.

13.3.4.4 Front disc - original equipment, or Commission Approved production based.

13.3.4.5 Front brake caliper - original equipment, or Commission Approved production based.

- 13.3.4.6 Rear disc - original equipment, or Commission Approved production based.
- 13.3.4.7 Rear brake caliper - original equipment, or Commission Approved production based.
- 13.3.4.8 Friction material – free. No carbon discs.
- 13.3.4.9 Equal hydraulic pressure on the same axle a requirement.
- 13.3.4.10 No water cooling systems for brakes allowed.

13.3.5 Suspension

Refer addendum 1, 2 & 3.

13.3.5.1 General:

- Closed loop control systems – electric, pneumatic or hydraulic that result in interconnecting front to rear or left to right, or adjust spring and damping parameters, or adjust ride height, are not allowed.
- No adjustments may be made from the crew cab. Only adjustments allowed will be directly on the suspension with the vehicle stationary.
- Suspension travel limited to 250mm for independent suspension, measured at the wheel centre, or 300mm for beam axle measured at the wheel centre with axle horizontal. Refer Art 2.6.
- The wheelbase for all vehicles competing in the class will be 2975mm, \pm 100 mm. The x-position of the front axle is free, respecting Art 13.3.8, Addendum 2 and the minimum Reference ground clearance of 300mm under sump guards.
The x - position of the rear axle is determined by the wheelbase and the position of the front axle.
- The track may be increased so as to fit inside the 2 metre wide bodywork.
- Suspension bush medium – free, including ball joints, Uniball/'rose' joints.
- The springs and dampers must act directly on either the suspension control arm, axle or upright/knuckle.
No rocker systems will be allowed.

13.3.5.2 Springs

Suspension springs are free, respecting Art 13.3.5.1.

13.3.5.3 Suspension dampers

Must be stand-alone mechanical/hydraulic/gas damper only.

- Valving is free.
- Number and location is free.

13.3.5.4 Anti-roll bars

- Only one anti-roll bar per axle is permitted.
- The adjustment of the anti-roll bars from the cockpit is forbidden.
- The anti-roll bar systems must be exclusively mechanical, with no activation or de-activation possible from the crew compartment, or with the vehicle moving.
- Any connections between front and rear anti-roll bars are forbidden.

13.3.5.5 Suspension knuckle/upright

- original or Commission Approved. If Commission Approved, the suspension knuckle/upright and wheel bearing/hub assemblies must be interchangeable left to right, bolt-on brackets excluded.

13.3.5.6 Control Arms, front

13.3.5.6.1 The lateral distance between the left and right lower control arm mounting points may not be less than 550 mm measured horizontally from left rotation centre to right rotation centre. The longitudinal and vertical position is free, respecting Addendum 2.

13.3.5.6.2 The lateral distance between the left and right upper control arm mounting points may not be less than the actual lateral distance between the lower control arms as measured between rotation centres. The longitudinal and vertical position is free.

13.3.5.6.3 Control arms may be manufactured from ferrous material only, otherwise free.

13.3.5.7 Suspension - rear

13.3.5.7.1 Live Rear Axle

All Class T vehicles must be converted to a live rear axle system, regardless of the original Arrangement fitted to the vehicle selected. Live rear axles must be modified to a 4 link system with coil springs and telescopic dampers. The upper arms of the system shall be A-arm type only. The upper A-arm and lower arms are of free design, but ferrous materials only may be used. The only area that this suspension system may occupy is 1.2 metre ahead of the new rear axle centre line and 250mm behind the new axle centre line and one metre above the ground at the specified ride height of 300mm.

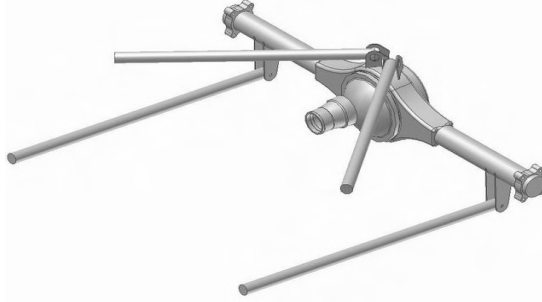

13.3.6 **Steering**

- The original steering system may be used.
- A Commission Approved steering system may be used.
- On all units, the rack and tube may be shortened.
- Track rods, steering arms and joints are free.
- If the steering column shaft used is not a standard production unit, a design verification for the component used must be produced with the vehicle for first scrutineering. Ample provision must be made for allowing the column and shaft to telescope or deflect away from the driver in the event of a frontal impact.

13.3.7 **Wheels, Rims and Tyres**

- 13.3.7.1 The use of magnesium wheels is not permitted. Steel or aluminium is the only materials authorised.
- 13.3.7.2 The Commission reserves the option to specify a control tyre by make, type and size.
- 13.3.7.3 Maximum tyre diameter is 810mm. Maximum tyre size is 235/85R16.

13.3.8 **Body and Chassis**

Refer Addenda 1, 2 & 3 and Art 1.5.

13.3.8.1 The chassis must either:

- derive from a chassis (or monocoque body) of a car produced in a quantity greater than 1000 per year (FIA or MSA approval required). In this case, the chassis/monocoque may only be modified in accordance with all the requirements in Part II: Classification and Vehicle Specifications.
- or be a steel tubular frame chassis incorporated in the safety cage in accordance with Articles 9, 10 and 11.

13.3.8.2 The body of the vehicle must be from the model range of the make of vehicle specified in the Technical Passport. The standard body profile side view proportions from the front of the grille, bonnet and fenders to the rear of the crew cab and to the rear of the load body must be retained. The same applies to the plan view, front view and rear view. The modifications are allowed in the spirit of retaining the production vehicle appearance, i.e. The standard body profile proportions must be retained.

- a) The standard windscreen aperture and rake must be maintained.
- b) The standard headlights and radiator grille to be retained and mounted in standard lay-out.
- c) The horizontal distance from the base of the windscreen to the front edge of the bonnet, may not exceed the standard vehicle dimension. To be measured on the vehicle centreline, with the sills set level.
- d) The vertical distance between the base of the windscreen and the horizontal centre of the headlight/grille assembly may not be less than the standard vehicle dimension. To be measured on the vehicle centreline, with the sills set level.
- e) The front and rear overhang dimensions are 660 mm minimum, and has to be maintained over a minimum lateral distance of 500mm around the centreline of the vehicle (250mm each side). The front and rear departure angles are free.
- f) The front bumper, bonnet and fenders may be modified respecting a), b), c), d) and e), and must blend in with the windscreen, headlights and grille in their original orientation to maintain the production vehicle appearance in standard body proportions.
- g) The three (side-, plan-, rear-) profiles of the cab and load body must reflect the profile proportions of the production vehicle.
- h) The width and height of the crew cab may be increased from standard to comply with the FIA regulations with the specific written permission of the Commission President.

- i) The crew cab may be original steel modified, or remanufactured in fiberglass composite with one covering layer of Carbon Fibre only for aesthetic purposes. Refer Art 13.1.9.ii).
 - j) The front doors must remain in the original production material or may be made of composite material, but must be of the original shape and size and be fitted to the racing vehicle using the original steel hinges with all the steel bolts in their original positions bolted onto the steel chassis frame. The original door locks must be retained, opening from inside and outside. Window winding mechanisms may be removed, respecting Art 13.1.23.
 - k) The doors must still provide sufficient protection for the occupants in the case of an accident.
 - l) Should the space below the floor of the crew cab be utilised for components and storage, the sills may be extended from the floor level downwards and laterally not wider than the maximum vehicle width of 2000mm blending into the wheel arch extensions.
 - m) The standard doors may be shortened at the bottom by up to 200mm, to accommodate the larger cab sills, respecting paragraph j) and remaking the bottom portion of the door frame in steel.
 - n) All window openings other than the cab rear window must be retained in their original position and be of the original size and shape. These windows other than the front door windows may be transparent, open or opaque. Refer Art 13.1.23.
- 13.3.8.3 The maximum width of the vehicle is 2 meters, excluding the rear view mirrors. The wheel arches and the cab sills may be extended to this maximum of 2 meter overall width by the use of fender flares and laterally extended sills. The wheel arches may be repositioned to accommodate the wheelbase and overhang specified. Seen in vertical projection, the body work must cover at least 120° of the upper circumference of the wheels situated above the wheel axis as viewed from the side. This width measurement must be checked with the ride height set at 300mm measured at the front under the sump guard, and the sills level. Refer Addendum 1.
- 13.3.8.4 Two air vents or two bulges to accommodate approved under-bonnet modifications, may be added to the bonnet of a racing vehicle, however, these may not protrude more than 50mm above the modified base profile of the bonnet.
- 13.3.8.5 Air ducting to rear mounted water radiators may be fitted on the passenger cabin roof, but should follow the roof line to maintain the profile of the cabin. These additions are subject to the specific approval of the Commission in writing through the Technical Delegate.
- 13.3.8.6 Vents or scoops may be added to the cabin roof for the purpose of providing ventilation for the driver and navigator. These vents must be blended to fit the roof profile.
- 13.3.8.7 The original body work sheet metal and hardware, onto which the headlights, radiator, and grille is mounted, may be removed and replaced with a fabricated structure designed to perform the same function, providing none of the other provisions in these regulations are contravened and the finished vehicle retains its original outward appearance.
- 13.3.8.8 The firewall between the engine compartment and the passenger compartment, along with the floor of the passenger compartment and the tunnel, which forms part of the floor, may be removed and refabricated in order to accommodate authorised non-standard components, respecting Articles 9 Safety Belts and 10 Seats and Seat mountings, and providing none of the other provisions in these regulations are contravened and the finished vehicle retains its original outward appearance. The new tunnel, floor and firewall may be fabricated from steel or composite. A single layer of carbon will be allowed on the top side of the tunnel, floor and firewall for aesthetic purposes. The Technical Delegate reserves the right to drill a 30mm hole with a hole saw in a place of his discretion to analyse the composition of the components. Refer Art 13.1.9.i) and ii.)
- 13.3.8.9 The production dashboard may be retained or remade in a similar shape and size in an alternative material which is non-metallic. All other trim should be removed. Refer Art 13.1.9.ii).
- 13.3.8.10 Competitors intending to convert station wagons, SUV's, panel vans etc. must obtain the prior approval of the Commission through the Technical Delegate, and be briefed on the Commission's specific interpretation of the class T rules and how they will apply to such vehicles.
- 13.3.8.11 The floor pan behind the crew may be cut and modified or remade to accommodate the fuel tank. The fuel tank and fuel lines must be separated from the cockpit by a liquid and fireproof bulkhead. Refer Art 7

- 13.3.9 Fuel System** - Refer Art 7.
- 13.3.9.1 The fuel tank size is free.
- 13.3.9.2 Fuel feed pumps are free.
- 13.3.9.3 Fuel coolers of the air to fuel type are authorised in the return lines.
- 13.3.10 Electrical System**
- 13.3.10.1 Battery size, type and location – free. Refer Art 8.
- 13.3.10.2 Wiring harness -- free.
- 13.3.10.3 **Lights** - Refer Art 8.
- 13.3.11 Cooling System**
- 13.3.11.1 The engine cooling water radiator/s and position is free. The addition of electric water pumps to aid water cooling is authorised. The addition of ducting components to improve airflow through the radiator is authorised.
- 13.3.11.2 **Transmission coolers** – free.
- 13.3.11.3 **Power Steering coolers** – free.
- 13.3.11.4 All coolers must be housed within the standard bodywork profiles. Minimal cutting of internal bodywork only is allowed to accommodate the fitting of these systems.
- 13.4 CLASS S - PRODUCTION VEHICLES, 4 LITRES**
- 13.4.1 General:**
- 13.4.1.1 Competitors with older vehicles not conforming completely to Class S rules, may apply to the Commission to enter. Entry will be allowed subject to performance limitation or enhancing controls, such as weight, restrictor, and engine, body, suspension and chassis deviations. Acceptance must be confirmed in writing and signed by both the Commission President and the Technical Delegate.
Refer Art 1.4,1.5, and 1.6.
- 13.4.1.2 For class S only, the minimum mass as specified in Art 3.1 will remain as in 2014, which is 60 kg higher.
Refer Art 3.1
- 13.4.2 Engines**
- 13.4.2.1 All Class S Vehicles must be fitted with Group N specification engines only.
- normally aspirated (NA) petrol engines, capacity not exceeding 4000cc. Engines with a throttle valve per cylinder will not be allowed.
- 13.4.2.2 An alternative engine may be selected from the same Marque (make, i.e. Nissan, Ford) of Production Vehicle, Commercial Vehicle, Bakkie, or Passenger Car.
- 13.4.2.3 Engine position. The intersection of the front face of the cylinder block and the crankshaft centreline must be more than 100mm forward of the front axle centreline.
Engine height to be governed by the Commission Approved front differential housing mounted generally on the front axle centreline, and the engine mounted over this differential. See Addendum 3.
- 13.4.2.4 For normally aspirated engines: The intake manifold must be original, or originate from the engine of a series vehicle in the marque. The addition of a spacer, maximum thickness 70mm, between the manifold and the cylinder head is the only modification permitted for adjustment. The manifolds must remain unmodified. All unused apertures must be sealed completely. No breather systems allowed in-between the restrictor and the cylinder head.
Electronic throttle bodies may be converted to mechanical actuation and vice versa, but the air passage and butterfly valve sizes must remain original.
- 13.4.2.5 A 2% capacity increase will be allowed for re-boring the cylinders. Written approval to be obtained from the CCRC.
- 13.4.2.6 Modifications allowed to external engine ancillaries:
- Exhaust manifolds and exhaust systems are free but must be made from ferrous material. Refer Art 4.
 - Flywheel to be original, or made of ferrous material only, otherwise free.
 - Engine mountings free. The attachment of the mounts to the engine block must be to the standard position.
 - Engine management system free. The use of a gear cut system (engine cut to aid gear change) is authorised. Refer Art 13.1.10.

- All unused external bolt-on ancillaries may be removed from the engine e.g. air conditioner pumps, heater pipes etc.
 - Power steering pumps and alternator as well as their brackets/mountings free.
- 13.4.3 Transmission/Driveline**
- 13.4.3.1 Gearbox**
- Only 4x4 drivelines are allowed. Mechanical drive only. No electric, hydraulic, pneumatic drives allowed. Hydraulic torque converters allowed.
- free from the marque with production ratio's only, or
 - Commission Approved gearbox. Refer C.A. list.
 - Ratios are free.
- 13.4.3.2 Transfer gearbox**
- free from the marque with internals free, or
 - Commission Approved transfer gearbox. Refer C.A. list.
- 13.4.3.3** Twin plate clutches may be used, no carbon components are allowed.
- 13.4.3.4 Front Axle/Differential assembly**
- original units may be retained, internal components free, or
 - Commission Approved front axle/differential assembly.
- 13.4.3.5 Rear Axle/Differential assembly**
- original units may be retained, internal components free, or
 - Commission Approved rear axle/differential assembly.
- 13.4.3.6 Prop shafts** free – ferrous material only.
- 13.4.3.7 Constant Velocity Joints (CV)**
- original CV joints, or
 - outer and inner CV joints Commission Approved.
- 13.4.3.8 Drive shafts**
- free, ferrous material only.
- 13.4.4 Brake System**
- 13.4.4.1** Original brake system may be used in its entirety, or
- 13.4.4.2** A racing pedal box system is authorised. The front-rear brake force balance may only be changed manually via a cable connected to the “balance bar” in the pedal box, turned by hand by the driver or navigator. No ABS or similar electronic control systems allowed.
- 13.4.4.3** The original hand brake system may be removed. The fitting of a hydraulic hand brake system is authorised.
- 13.4.4.4** Front disc - original equipment, or Commission Approved production based.
- 13.4.4.5** Front brake caliper - original equipment, or Commission Approved production based.
- 13.4.4.6** Rear disc - original equipment, or Commission Approved production based.
- 13.4.4.7** Rear brake caliper - original equipment, or Commission Approved production based.
- 13.4.4.8** Friction material – free. No carbon discs.
- 13.4.4.9** Equal hydraulic pressure on the same axle a requirement.
- 13.4.4.10** No water cooling systems for brakes allowed.
- 13.4.5 Suspension**
- Refer addendum 1, 2, 3.
- 13.4.5.1 General**
- Closed loop control systems – electric, pneumatic or hydraulic that result in interconnecting front to rear or left to right or adjust spring and damping parameters, or adjust ride height, are not allowed.
- No adjustments may be made from the crew cab. Only adjustments allowed will be directly on the suspension with the vehicle stationary.
 - Suspension travel limited to 250mm for independent suspension, measured at the wheel centre, or 300mm for beam axle measured at the wheel centre with axle horizontal. Refer Art 2.6.
 - The wheelbase for all vehicles competing in the class will be 2975mm, \pm 100 mm. The x-position of the front axle is free, respecting Art 13.4.8, Addendum 2 and the minimum Reference ground clearance of 300mm under sump guards.

- The x - position of the rear axle is determined by the wheelbase and the position of the front axle.
- The track may be increased so as to fit inside the 2 metre wide bodywork.
- Suspension bush medium – free, including ball joints, Uniball/‘rose’ joints.
- The springs and dampers must act directly on the suspension control arm, axle or upright/knuckle. No rocker systems will be allowed.

13.4.5.2 **Springs**

- Suspension springs are free, respecting Art 13.4.5.1.

13.4.5.3 **Suspension dampers**

- Must be stand-alone mechanical/hydraulic/gas damper only.
- Valving is free.
- Number and location is free.
- Dampers for Class S must be Commission Approved and recorded in the Technical Passport of the vehicle.

13.4.5.4 **Anti-roll bars**

- Only one anti-roll bar per axle is permitted.
- The adjustment of the anti-roll bars from the cockpit is forbidden.
- The anti-roll bar systems must be exclusively mechanical, with no activation or deactivation possible from the crew compartment, or with the vehicle moving.
- Any connections between front and rear anti-roll bars are forbidden.

13.4.5.5 Suspension knuckle/upright – original or Commission Approved. If Commission Approved, the suspension knuckle/upright and wheel bearing/hub assemblies to be interchangeable left to right, bolt-on brackets excluded.

13.4.5.6 **Control Arms**

13.4.5.6.1 The lateral distance between the left and right lower control arm mounting points may not be less than 550 mm measured horizontally from left rotation centre to right rotation centre. The longitudinal and vertical position is free, respecting Art 13.4.5.1. Refer Addendum 2.

13.4.5.6.2 The lateral distance between the left and right upper control arm mounting points may not be less than the actual lateral distance between the lower control arms as measured between rotation centres. The longitudinal and vertical position is free.

13.4.5.6.3 Control arms may be original equipment, or manufactured from ferrous material only, otherwise free.

13.4.5.7 **Suspension - rear**

Live Rear Axle - All Class S vehicles must be converted to a live rear axle system, regardless of the original arrangement fitted to the vehicle selected. Independent rear suspension will not be allowed. Live rear axles must be modified to a 4 link system with coil springs and telescopic dampers. The upper arms of the system shall be A-arm type only. The upper A-arm and lower arms are of free design, but ferrous materials only may be used. The only area that this suspension system may occupy is 1.2metre ahead of the new rear axle centre line and 250mm behind the new axle centre line and one metre above the ground at the specified ride height of 300mm.

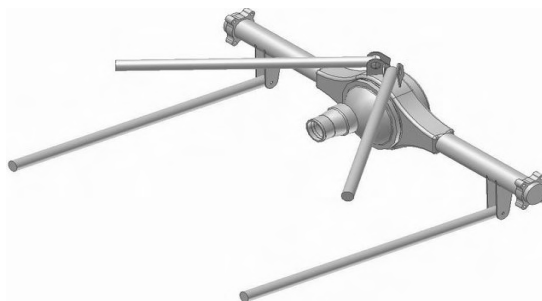

13.4.6 **Steering**

- The original steering system may be used.
- A Commission Approved steering system may be used.
- On all units, the rack and tube may be shortened.

- Track rods, steering arms and joints are free.
- If the steering column shaft used is not a standard production unit, a design verification for the component used must be produced with the vehicle for first scrutineering. Ample provision must be made for allowing the column and shaft to telescope or deflect away from the driver in the event of a frontal impact.

13.4.7 **Wheels, Rims and Tyres**

13.4.7.1 The use of magnesium wheels is not permitted. Steel or aluminium is the only materials authorised.

13.4.7.2 The Commission reserves the option to specify a control tyre by make, type and size.

13.4.7.3 Maximum tyre diameter is 810mm. Maximum tyre size is 235/85R16.

13.4.8 **Body and Chassis**

Addenda 1, 2 & 3 and Art 1.5

13.4.8. The chassis must either:

- derive from a chassis (or monocoque body) of a car produced in a quantity greater than 1000 per year (FIA or MSA approval required). In this case, the chassis/monocoque may only be modified in accordance with all the requirements in Part II: Classification and Vehicle Specifications.
- or be a steel tubular frame chassis incorporated in the safety cage in accordance with Articles 9, 10 and 11.

13.4.8.1 The body of the vehicle must be from the model range of the make of vehicle specified in the Technical Passport. The standard body profile side view proportions from the front of the grille, bonnet and fenders to the rear of the crew cab and to the rear of the load body must be retained. The same applies to the plan view, front view and rear view. The modifications are allowed in the spirit of retaining the production vehicle appearance, i.e. the standard body profile proportions must be retained.

- a) The standard windscreen aperture and rake must be maintained.
- b) The standard headlights and radiator grille to be retained and mounted in standard lay-out.
- c) The horizontal distance from the base of the windscreen to the front edge of the bonnet, may not exceed the standard vehicle dimension. To be measured on the vehicle centreline, with the sills set level.
- d) The vertical distance between the base of the windscreen and the horizontal centre of the headlight/grille assembly may not be less than the standard vehicle dimension. To be measured on the vehicle centreline, with the sills set level.
- e) The front and rear overhang dimensions are 660 mm minimum, and has to be maintained over a minimum lateral distance of 500mm around the centreline of the vehicle (250mm each side). The front and rear departure angles are free.
- f) The front bumper, bonnet and fenders may be modified respecting a), b), c), d) and e), and must blend in with the windscreen, headlights and grille in their original orientation to maintain the production vehicle appearance in standard body proportions.
- g) The three (side-, plan-, rear-) profiles of the cab and load body must reflect the profile proportions of the production vehicle.
- h) The width and height of the crew cab may be increased from standard to comply with the FIA regulations with the specific written permission of the Commission President.
- i) The crew cab may be original steel modified, or remanufactured in fiberglass composite with one covering layer of Carbon Fibre only for aesthetic purposes. Refer Art 13.1.9.ii).
- j) The front doors must remain in the original production material, be of the original shape and size and be fitted to the racing vehicle using the original steel hinges with all the steel bolts in their original positions bolted onto the steel chassis frame. The original door locks must be retained, opening from inside and outside. Window winding mechanisms may be removed, respecting Art 13.1.23.
- k) A 75% portion of the interior flat area of the production door frame, as covered by the production interior cover, may selectively be cut away to lighten the door without affecting the structural rigidity of the door adversely. The doors must still provide sufficient protection for the occupants in the case of an accident.
- l) Should the space below the floor of the crew cab be utilised for components and storage, the sills may be extended from the floor level downwards and laterally not wider than the maximum vehicle width of

2000mm blending into the wheel arch extensions.

- m) The standard doors may be shortened at the bottom by up to 200mm, to accommodate the larger cab sills, respecting paragraphs j) and k) and remaking the bottom portion of the door frame in steel.
- n) All window openings other than the cab rear window must be retained in their original position and be of the original size and shape. These windows other than the front door windows may be transparent, open or opaque. Refer Art 13.1.23.

13.4.8.2 The maximum width of the vehicle is 2 meters, excluding the rear view mirrors. The wheel arches and the cab sills may be extended to this maximum of 2 meter overall width by the use of fender flares and laterally extended sills. The wheel arches may be repositioned to accommodate the wheelbase and overhang specified.

Seen in vertical projection, the body work must cover at least 120° of the upper circumference of the wheels situated above the wheel axis as viewed from the side. This width measurement must be checked with the ride height set at 300mm measured at the front under the sump guard, and the sills level.

Refer Addendum 1.

13.4.8.3 Two air vents or two bulges to accommodate approved under-bonnet modifications, may be added to the bonnet of a racing vehicle, however, these may not protrude more than 50mm above the modified base profile of the bonnet.

13.4.8.4 Air ducting to rear mounted water radiators may be fitted on the passenger cabin roof, but should follow the roof line to maintain the profile of the cabin. These additions are subject to the specific approval of the Commission in writing through the Technical Delegate.

13.4.8.5 Vents or scoops may be added to the cabin roof for the purpose of providing ventilation for the driver and navigator. These vents must be blended to fit the roof profile.

13.4.8.6 The original body work sheet metal and hardware, onto which the headlights, radiator, and grille is mounted, may be removed and replaced with a fabricated structure designed to perform the same function, providing none of the other provisions in these regulations are contravened and the finished vehicle retains its original outward appearance.

13.4.8.7 The firewall between the engine compartment and the passenger compartment, along with the floor of the passenger compartment and the tunnel, which forms part of the floor, may be removed and refabricated in order to accommodate authorised non-standard components, respecting Articles 9 Safety Belts and 10 Seats and Seat mountings, and providing none of the other provisions in these regulations are contravened and the finished vehicle retains its original outward appearance. The new tunnel, floor and firewall may be fabricated from steel or composite. A single layer of carbon will be allowed on the top side of the tunnel, floor and firewall for aesthetic purposes. The Technical Delegate reserves the right to drill a 30mm hole with a hole saw in a place of his discretion to analyse the composition of the components. Refer Art 13.1.9.i) and ii.)

13.4.8.8 The production dashboard may be retained or remade in a similar shape and size in an alternative material which is non-metallic. All other trim should be removed. Refer Art 13.1.9. ii).

13.4.8.9 Competitors intending to convert station wagons, SUV's, panel vans etc. must obtain the prior approval of the Commission through the Technical Delegate, and be briefed on the Commission's specific interpretation of the class T rules and how they will apply to such vehicles.

13.4.8.10 The floor pan behind the crew may be cut and modified or remade to accommodate the fuel tank. The fuel tank and fuel lines must be separated from the cockpit by a liquid and fireproof bulkhead. Refer Art 7.

13.4.9 Fuel System - Refer Art 7.

13.4.9.1 The fuel tank size is free.

13.4.9.2 Fuel feed pumps are free.

13.4.9.3 Fuel coolers of the air to fuel type are authorised in the return lines.

13.4.10 Electrical System

13.4.10.1 Battery size, type and location – free. Refer Art 8.

13.4.10.2 Wiring harness - free.

13.4.10.3 Lights - Refer Art 8.

13.4.11 Cooling System

13.4.11.1 The engine cooling water radiator/s and position is free. The addition of electric water pumps to aid water

cooling is authorised. The addition of ducting components to improve airflow through the radiator is authorised.

13.4.11.2 **Transmission coolers** – free

13.4.11.3 **Power steering coolers** – free

13.4.11.4 All coolers and ducting must be housed within the standard bodywork profiles. Minimal cutting of internal bodywork only is allowed to accommodate the fitting of these systems.

13.5 **CLASS D - PRODUCTION BASED VEHICLES WITH CHASSIS, 4 LITRES**

NOTE:

Competitors contemplating the purchase or construction of a new vehicle for class D must ensure that the specifications and design is acceptable to the Commission and acceptance has been confirmed in writing and signed by both the Commission President and the Technical Delegate. Refer Art 1.4, 1.5, and 1.6.

13.5.1 **Engine**

13.5.1.1 Naturally aspirated petrol engines with four cylinders or more, and a maximum capacity of 4000cc, or alternatively, a Turbo Diesel Engine with a maximum capacity of 3200cc.

13.5.2.2 All Class D Vehicles must be fitted with Group N specification engines.

13.5.1.3 The turbo charger fitted to a diesel engine selected must be homologated.

13.5.1.4 Exhaust manifold and exhaust system is free Refer Art 4.

13.5.1.5 Flywheel to be original, or made of ferrous material only, otherwise free.

13.5.1.6 Engine mountings are free, however the engine must remain in its original position. The attachment of the mounts to the engine block must be to the standard position.

13.5.1.7 Cooling systems for engine water, lubrication oil, power steering, gearbox and transmission oil are free, Except that the bodywork regulations must be respected. Water radiator must be retained in its original area as in the production vehicle, e.g. in front of the engine.

13.5.1.8 Air cleaner system and position is free.

13.5.1.9 Air conditioners and heaters may be removed.

13.5.1.10 Piggyback, remapped and direct replacement ECU's are permitted. The engine wiring harness, connectors and sensors are free. The air mass sensor is free. The air valve may be enlarged provided it is still housed within the standard throttle body. Refer Art 13.1.10.

13.5.1.11 No telemetry is permitted. No traction control systems or devices are permitted. Refer Art 13.1.10 and 14.

13.5.1.12 Diesel engine intercoolers must comply with clauses 13.2.6, 7 and 8.

13.5.2 **Transmission/Driveline**

13.5.2.1 Drive 2x4 or 4x4.

13.5.2.2 Clutch and pressure plates are free, but are restricted to a maximum of twin plates. Carbon friction plates are not allowed.

13.5.2.3 Gearbox may be replaced with any unit from the model range of the vehicle, or a commission approved gearbox. Gearbox mountings are free.

13.5.2.4 Transfer case may be replaced with any unit from the model range of the vehicle, internals free or a commission approved unit. Transfer case mountings are free.

13.5.2.5 Axle housings from the same model range as the vehicle may be used including rear housings being used in front and front axle housings being used at rear. Axle housings may be reinforced.

13.5.2.6 Internal axle components are free, including drive shafts but ferrous materials only.

13.5.2.7 Prop shafts and centre bearings are free but ferrous materials only.

13.5.3 **Brake System**

13.5.3.1 Standard braking system or disc brakes front and rear from a production vehicle – commission approved. A Racing pedal box system may be fitted to replace the standard system.

Friction material is free.

Hand brake system is free.

Brake bias valve may be added to the standard system.

Brake tubing / hoses and location free provided the quality is better or equivalent to the original.

13.5.4 **Electrical System**

13.5.4.1 Battery size, type and location are free.

13.5.4.2 The rest of the system is free provided it complies with the safety standards. Refer Art 8.

13.5.5 **Suspension**

13.5.5.1 The original suspension pick up positions must be retained. Use of the original pick up brackets on the chassis is preferred, with additional reinforcing.

13.5.5.2 Spring rates, torsion bar diameters as well as the free camber height of leaf springs are free.

13.5.5.3 Shock absorbers as well as their mounting / location are free.

13.5.5.4 Bump stops are free including the use of hydraulic bump stops.

13.5.5.5 Suspension bush materials are free.

13.5.5.6 Dual or any form of additional suspension medium is not permitted.

13.5.5.7 Suspension travel maximum for front suspension 250mm. Suspension travel maximum for rear Suspension 300mm. Method of measurement. Refer Art 2.6.

13.5.5.8 Anti-tramp rods may be added but these are restricted to one per side. Refer Art 2.8.

13.5.5.9 Leaf springs may be replaced with coil springs. As per the layout below.

13.5.5.10 **Rear Suspension**

All Class D vehicles may be converted to a live rear axle system, regardless of the original arrangement fitted to the vehicle selected. Independent rear suspension will not be allowed. Live rear axles must be modified to a 4 link system with coil springs and telescopic dampers. The upper arms of the system shall be A-arm type only. The upper A-arm and lower arms are of free design, but ferrous materials only may be used. The only area that this suspension system may occupy is 1.2 metre ahead of the new rear axle centre line and 250mm behind the new axle centre line and one metre above the ground at the specified ride height of 300mm.

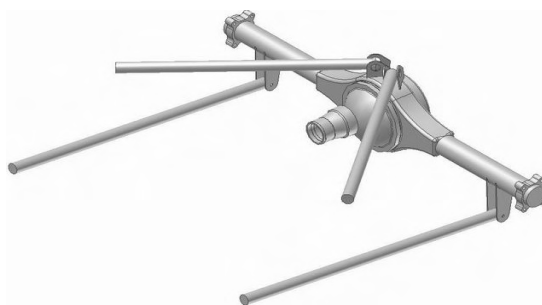

13.5.5.11

Front suspension

- Ball joints are free but must come from a production vehicle.
- Top wishbone is free but design must be commission approved for each, make and model.
- Bottom wishbone must be standard, but may be reinforced.
- Standard uprights must be retained, but may be reinforced.
- Steering rack or steering box must be standard or Toyota Land Cruiser or production based, commission approved unit.
- All steering links and joints are free.

13.5.6 **Rims/Tyres**

Rims are free provided they do not protrude past the width of the standard body. At least one third of the plan view of the tyre must be covered by the wheel arch bodywork when viewed from above.

Tyres, Refer Art 13.1.19.

13.5.7 **Chassis**

13.5.7.1 Standard production chassis of the same model as body and engine.

13.5.7.2 Chassis may be reinforced provided the original silhouette is retained.

13.5.7.3 Mounting points for roll cage, fuel tanks and other items may be added.

13.5.7.4 The chassis rail, in excess of 600mm, ahead of the centre line of the front wheel, may be removed. The rear part of the chassis may be removed from a point, no further forward, than 250mm in front of the

- centre of the rear axle for the coil sprung live axle conversion only. The chassis rail width shall remain as standard.
- 13.5.7.5 Unused mounting points for original items such as shock absorbers, exhaust, load body, fuel tank and spare wheel may be removed.
- 13.5.7.6 One rear cross member may be removed or relocated to accommodate the fuel tank or spare wheels.
- 13.5.8 Body**
- 13.5.8.1 This class is for bakkies and SUV's only.
The body must be from the same model range as the chassis. The standard body profile side view, from the front of the grille, bonnet and fenders to the rear of the cab must be retained. The same applies to the plan view, front view and rear view. The front bumper may be replaced by a fiberglass replica, modified below the height of the top of the wheel, Refer Addendum 1. The replica front bumper must blend in with fenders, lights and grille to maintain the production vehicle appearance. The body must be maintained in its original position on the chassis from all points of view, i.e. height, longitudinal and lateral position.
- 13.5.8.2 All interior trim and door panels may be removed.
- 13.5.8.3 The production dashboard may be retained or remade in a similar shape and size in an alternative material which is non-metallic. All other trim should be removed. Refer Art 13.1.9.i) and ii).
- 13.5.8.4 Seats shall be replaced with FIA approved types. Seat mountings shall be FIA approved or comply with FIA requirements. Refer Art 9 and 10.
- 13.5.8.5 Rear seats may be removed.
- 13.5.8.6 Windows. Refer Art 8.1.23.
- 13.5.8.7 Bonnet and fenders may be replaced with fiberglass replicas, provided the original shape and profile are retained.
- 13.5.8.8 The load body of a bakkie may be removed, provided the side panels or fiberglass replicas of the panels are retained. The load body panels may be modified inside view to suit the wheelbase and exit angle. Refer Addendum 1 for specifications.
- 13.5.8.9 Vents or scoops may be added to the roof for ventilation. Where additional vents and scoops are required for functional reasons to aid cooling, these additions are subject to the specific approval of the commission through the Technical Delegate, in writing.
- 13.5.8.10 The standard fenders may not be flared. Commercially available over-fenders may be fitted.
- 13.5.8.11 A bakkie rear cab window may be replaced with polycarbonate type material, minimum 3 mm thick. Refer Art 8.1.23.
- 13.5.9 Fuel System**
- 13.5.9.1 Fuel tank, capacity and location are free. Fuel tank construction as well as the mounting thereof shall be approved by the MSA Technical Delegate. Refer Art 7.
- 13.5.9.2 Fuel filters, pumps and pipes are free.
- 13.5.10 Crew**
- Two crew members.
- 13.5.11 Minimum Weight and Inlet Air Restrictors Minimum weight for petrol powered vehicles 1750kg Minimum weight for Diesel powered vehicles 1800kg Inlet air restrictor
Petrol engines - 35mm
Turbo diesels - 37mm
- 13.6 CLASS E - PRODUCTION BASED VEHICLES WITH CHASSIS, 3.0 LITRE**
- NOTE:**
Competitors contemplating the purchase or construction of a new vehicle for class E must ensure that the specifications and design is acceptable to the Commission and acceptance has been confirmed in writing and signed by both the Commission President and the Technical Delegate. Refer Art 1.4, 1.5, 1.5, 1.7.
- 13.6.1 Engine**
- 13.6.1.1 Four (4) Cylinder naturally aspirated petrol or turbo charged diesel. Maximum actual engine capacity not to exceed 3000cc, petrol or diesel.
- 13.6.1.2 The engine must be from the same model range as the body and chassis.
- 13.6.1.3 All vehicles completed after 1 December 2010, must be fitted with Group N specification engines.

- 13.6.1.4 The original turbo unit must be retained.
- 13.6.1.5 All vehicles selected to run in this class that are fitted with fuel injection as standard, must retain the standard system. The system includes the inlet manifold and standard throttle body. The air valve may be enlarged provided it is still housed within the standard throttle body. Internal porting and metal removal only is allowed.
- 13.6.1.6 Intake manifold for carburetors are free.
- 13.6.1.7 Exhaust manifold and exhaust systems are free.
- 13.6.1.8 Flywheel to be original, or made of ferrous material only, otherwise free.
- 13.6.1.9 Engine mountings are free provided the engine retains its original position in all directions. The attachment of the mounts to the engine block must be to the standard position.
- 13.6.1.10 Water radiator is free but must retain its original position in all directions.
- 13.6.1.11 Air cleaner system and position is free.
- 13.6.1.12 Air conditioners and heaters may be removed.
- 13.6.1.13 Piggyback, remapped and direct replacement ECU's are permitted. The engine wiring harness, Connectors and sensors are free. The air mass sensor is free. No telemetry is permitted. No traction control systems or devices are permitted. Refer Art 13.1.10 and 14.
- 13.6.2 Transmission/Drive Line**
- 13.6.2.1 Drive 2x4 or 4x4.
- 13.6.2.2 Clutch and pressure plates are free, but are restricted to a maximum of twin plates. Carbon friction plates are not allowed.
- 13.6.2.3 Gearbox may be replaced with any unit from the model range of the vehicle.
- 13.6.2.4 Transfer case mountings are free, as are the internals.
- 13.6.2.5 Front diff output shafts are free. Ferrous materials only.
- 13.6.2.6 Front drive shafts are free. Ferrous materials only.
- 13.6.2.7 Axle housings from the same model range as the vehicle may be used including rear housings being used in front and front axle housings being used at rear. Axle housings may be reinforced.
- 13.6.2.8 Internal axle components are free. Ferrous materials only.
- 13.6.2.9 Prop shafts and centre bearings are free. Ferrous materials only.
- 13.6.3 Brake System**
- 13.6.3.1 Standard braking system to be retained in its entirety, with the exception of the items listed below.
- 13.6.3.2 Friction material is free.
- 13.6.3.3 Hand brake system is free.
- 13.6.3.4 Brake bias valve may be added to the standard system.
- 13.6.3.5 Brake tubing / hoses and location free provided the quality is better or equivalent to the original.
- 13.6.4 Electrical System
- 13.6.4.1 Battery size, type and location are free. The rest of the system is free provided it complies with the safety standards. Refer Art 8.
- 13.6.5 Suspension**
- 13.6.5.1 The original suspension mounting points must be retained, but may be reinforced.
- 13.6.5.2 Spring rates, torsion bar diameters as well as the free camber height of leaf springs are free.
- 13.6.5.3 Original suspension components may be reinforced only and may not be changed.
- 13.6.5.4 Shock absorbers and their mounting points of shock absorbers are free.
- 13.6.5.5 Bump stops are free, including the use of hydraulic bump stops.
- 13.6.5.6 Suspension bush materials are free.
- 13.6.5.7 Duel or any form of additional suspension medium is not permitted.
- 13.6.5.8 Suspension travel maximum for front suspension 250mm. Suspension travel maximum for rear suspension 300mm. Method of measurement Refer Art 2.6.
- 13.6.5.9 Anti-tramp rods may be added. Refer Art 2.8.
- 13.6.5.11 Leaf spring suspension at the rear must be retained.
- 13.6.6 Rims/Tyres**
- 13.6.6.1 Rims are free provided they do not protrude past the width of the standard body.
At least one third of the plan view of the type must be covered by the wheel arch bodywork when viewed

from above. Tyres, Refer Art 13.1.19.

13.6.7 Steering

13.6.7.1 Power steering is permitted.

13.6.7.2 A steering box or steering rack fitted as standard may be replaced with a Toyota Hilux or Land Cruiser unit.

13.6.7.3 All steering links and joints are free.

13.6.8 Chassis

13.6.8.1 Standard production chassis of the same model range as the body and engine.

13.6.8.2 Chassis may be reinforced provided the original silhouette is retained.

13.6.8.3 Mounting points for roll cage, fuel tanks and other items may be added.

13.6.8.4 Bush bars, rear bumper and protective/skid plates may be added.

13.6.8.5 No part of the original chassis rail may be removed.

13.6.8.6 For monocoque construction vehicles the total monocoque must be retained and only reinforcing is permitted.

13.6.8.7 Unused mounting points for original items such as shock absorbers, exhaust, load body, fuel tank and spare wheel may be removed.

13.6.8.8 One rear cross member may be removed or relocated to accommodate the fuel tank or spare wheels.

13.6.9 Body

13.6.9.1 The body must be from the same make and model range as the chassis. The standard body profile side view from the front of the grille, bonnet and fenders to the rear of the cab must be retained. The same applies to the plan view, front view and rear view. The front bumper may be replaced by a fiberglass replica, modified below the height of the top of the wheel. Refer Addendum 1. The replica front bumper must blend in with fenders, lights and grille to maintain the production vehicle appearance. The body must be retained in its original position on the chassis from all points of view, i.e. height, longitudinal and lateral position.

13.6.9.2 All interior trim and door panels may be removed.

13.6.9.3 The production dashboard may be retained or remade in a similar shape and size in an alternative material which is non-metallic. All other trim should be removed. Refer Art 13.1.9.i) and ii).

13.6.9.4 Crew seats shall be replaced with FIA approved types. Seat mountings shall be FIA approved or comply With the FIA requirements. Refer Art 9 and 10.

13.6.9.5 Rear seats may be removed.

13.6.9.6 Windows. Refer Art 13.1.23.

13.6.9.7 Bonnet and fenders may be replaced with fiberglass replicas, provided the original shape and profile are retained.

13.6.9.8 The load body of a bakkie may be removed, provided the side panels or fiberglass replicas of the panels are retained.

The load body panels may be modified in side view to suit the wheelbase and exit angle.

Refer Addendum 1 for specifications.

13.6.9.9 A station wagon rear and side windows may be removed or replaced with fiberglass or aluminium panels.

13.6.9.10 The floor or the rear body section of a station wagon may be removed, provided there is a firewall between the occupants and the fuel tanks. Refer Art 7.

13.6.9.11 Vents or scoops may be added to the roof for ventilation.

13.6.9.12 The fenders may not be flared.

13.6.9.13 A station wagon rear doors may be removed.

13.6.9.14 A bakkie rear cab window may be replaced with polycarbonate type material.

13.6.10 Fuel System

13.6.10.1 Fuel tank, capacity and location are free. Fuel tank construction as well as the mounting thereof shall be approved by the MSA Technical Delegate. Refer Art 7.

13.6.10.2 Fuel filters pumps and pipes are free

13.6.11 Crew Two crew members.

13.6.12 Minimum Weights and Restrictors

13.6.12.1 Weight - 1700kg

13.6.12.2 Restrictors
Petrol – exempt.
Turbo Diesel - 39mm

Addendum 1 Bodywork

Silhouette formula – Only change to silhouette where specified

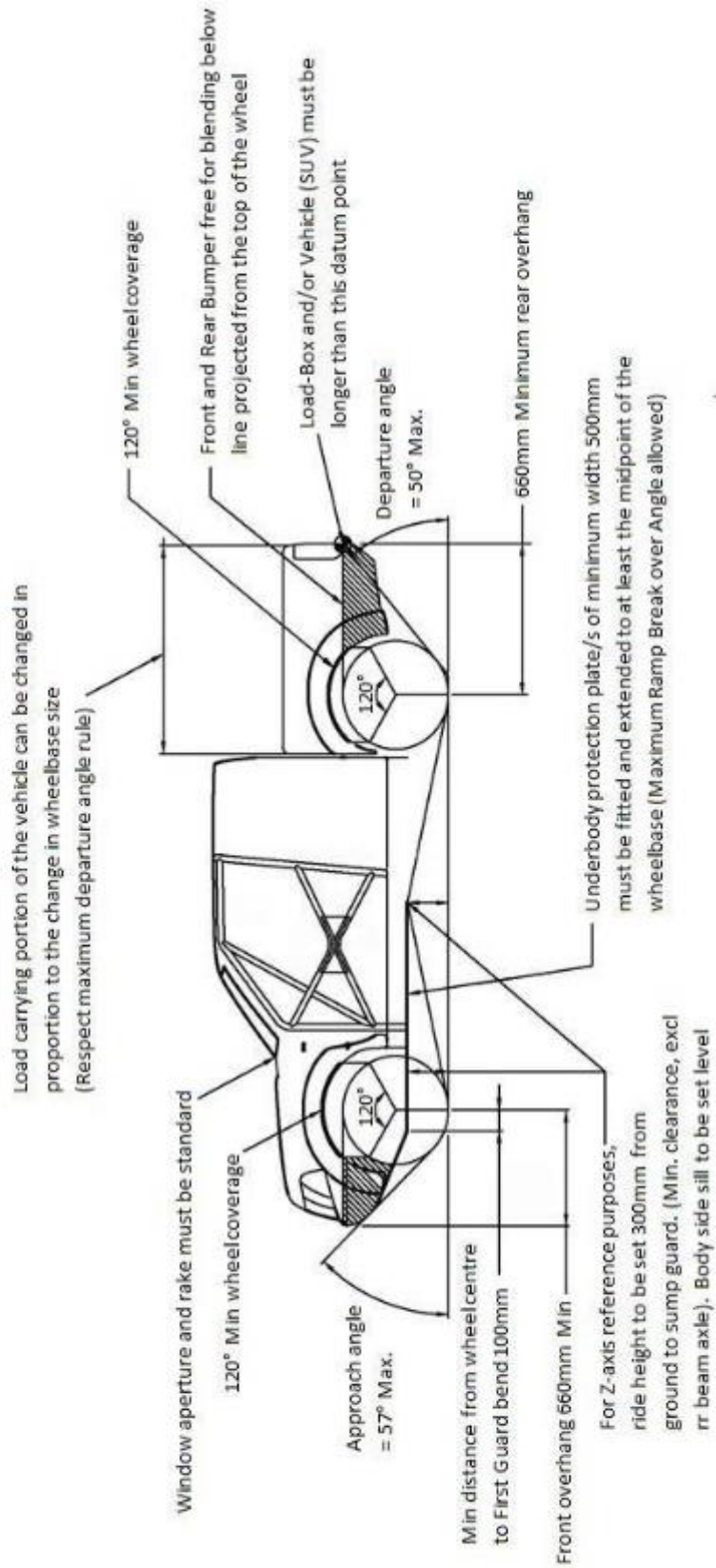

Addendum 2 Suspension

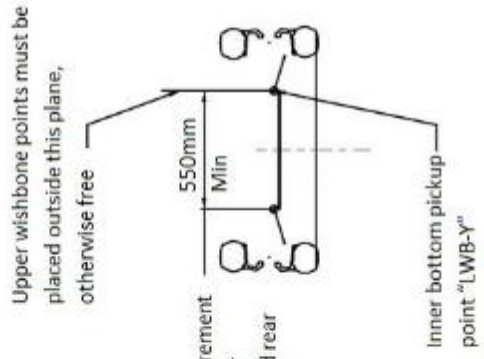
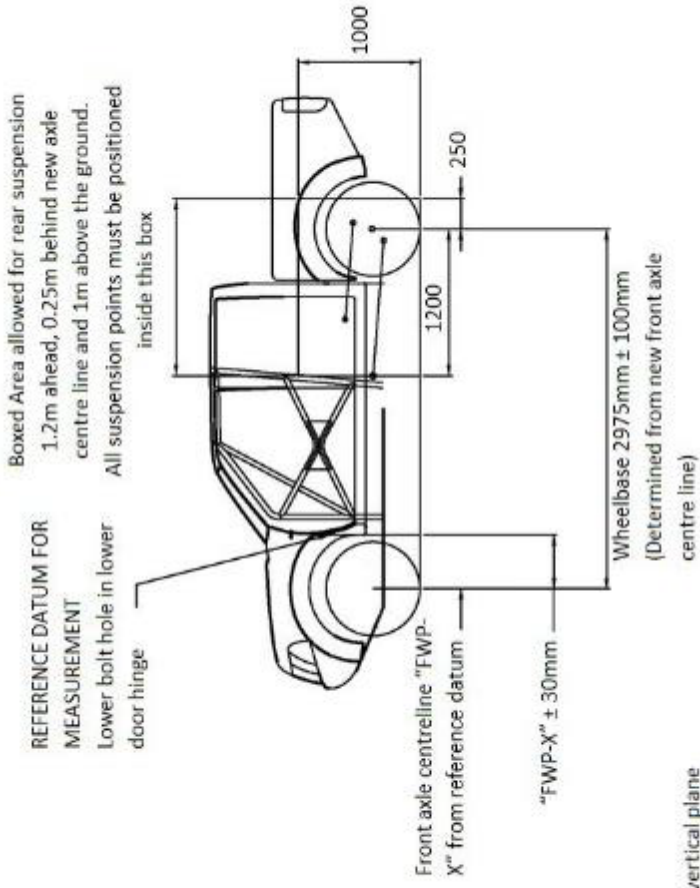

Standard reference measurement
for lower control arm inner
points on chassis, front and rear

NOTE:
Front axle centre line is the vertical plane
through the front wheel centres in the straight
ahead steering position

Addendum 3 Engine Position

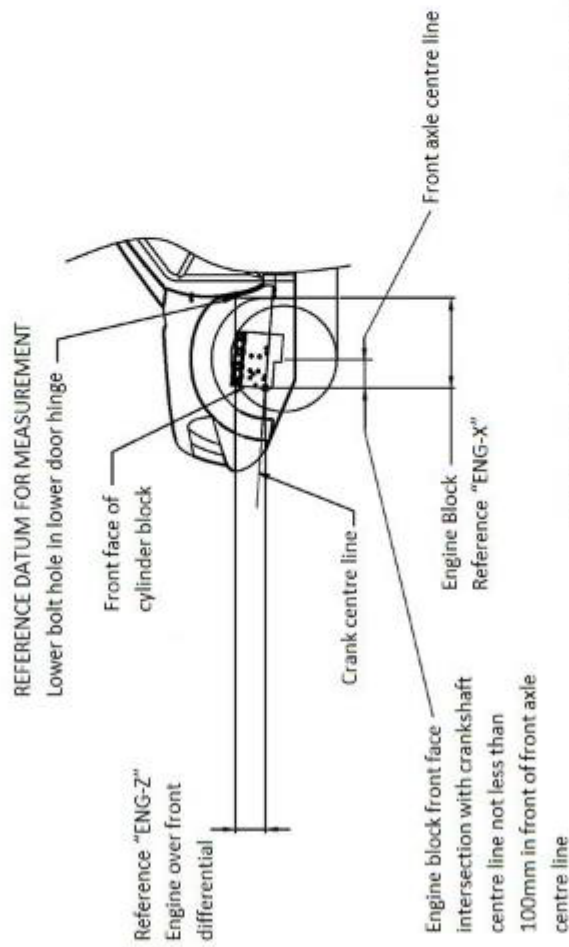

MASTER DIMENSIONS TABLE	
VEHICLE MAKE	
VEHICLE MODEL	
VEHICLE MANUFACTURE YEAR	
ENGINE MAKE AND MODEL	
ENGINE: X	
ENGINE: Z	
FRONT WHEEL POSITION: "FMP-X"	
LOWER WISHBONE POSITION: "LWB-Y"	
WHEELBASE	
FRONT OVERHANG	
REAR OVERHANG	

Relative to the original engine specified the following applies:

(Reference is the fitted engine mounted as original)

Note 1: Engine may be rotated around the crank axis $\pm 5^\circ$

Note 2: Engine may be moved left or right to facilitate fitment

Note 3: The height of the rear of the engine is free

Addendum 4 (FIA requirement)

Drawing 285-1

